

SITE LAYOUT PLANNING FOR DAYLIGHT AND SUNLIGHT

A guide to good practice

SECOND EDITION

Paul Littlefair



bre press

bretrust

SITE LAYOUT PLANNING FOR DAYLIGHT AND SUNLIGHT

A guide to good practice

Paul J Littlefair



bre press

bretrust

This work has been funded by BRE Trust. Any views expressed are not necessarily those of BRE Trust. While every effort is made to ensure the accuracy and quality of information and guidance when it is first published, BRE Trust can take no responsibility for the subsequent use of this information, nor for any errors or omissions it may contain.

The mission of BRE Trust is 'Through education and research to promote and support excellence and innovation in the built environment for the benefit of all'. Through its research programmes BRE Trust aims to achieve:

- a higher quality built environment
- built facilities that offer improved functionality and value for money
- a more efficient and sustainable construction sector, with
- a higher level of innovative practice.

A further aim of BRE Trust is to stimulate debate on challenges and opportunities in the built environment.

BRE Trust is a company limited by guarantee, registered in England and Wales (no. 3282856) and registered as a charity in England (no. 1092193) and in Scotland (no. SC039320).

Registered Office: Bucknalls Lane, Garston, Watford, Herts WD25 9XX

BRE Trust
Garston, Watford WD25 9XX
Tel: 01923 664743
Email: secretary@bretrust.co.uk
www.bretrust.org.uk

BRE Trust and BRE publications are available from
www.brebookshop.com

or
IHS BRE Press
Willoughby Road
Bracknell RG12 8FB
Tel: 01344 328038
Fax: 01344 328005
Email: brepres@ihs.com

Requests to copy any part of this publication should be made to the publisher:

IHS BRE Press
Garston, Watford WD25 9XX
Tel: 01923 664761
Email: brepres@ihs.com

Printed on paper sourced from responsibly managed forests

The publisher accepts no responsibility for the persistence or accuracy of URLs referred to in this publication, and does not guarantee that any content on such websites is, or will remain, accurate or appropriate.

CONTENTS

Summary	v
How to use the guide	vii
Glossary	viii
1 INTRODUCTION	1
2 LIGHT FROM THE SKY	2
2.1 New development	2
2.2 Existing buildings	7
2.3 Adjoining development land	11
3 SUNLIGHTING	14
3.1 New development	14
3.2 Existing buildings	16
3.3 Gardens and open spaces	18
4 SOLAR ENERGY	21
4.1 Introduction	21
4.2 Passive solar energy	21
4.3 Active solar thermal	24
4.4 Photovoltaics	24
4.5 General considerations	24
5 OTHER ISSUES	25
5.1 Introduction	25
5.2 View	25
5.3 Privacy	25
5.4 Security	26
5.5 Access	26
5.6 Enclosure	26
5.7 Microclimate	26
5.8 Solar dazzle	28
REFERENCES	29
BIBLIOGRAPHY	30
APPENDICES	
Appendix A Indicators to calculate access to skylight, sunlight and solar radiation	32
Appendix B Waldram diagram to calculate vertical sky component	49
Appendix C Interior daylight recommendations	53
Appendix D Plotting the no sky line	56
Appendix E Rights to light	60
Appendix F Setting alternative target values for skylight and sunlight access	62
Appendix G Calculation of sun on the ground	65
Appendix H Trees and hedges	70
Appendix I Environmental impact assessment	73
INDEX	74



SUMMARY

This guide gives advice on site layout planning to achieve good sunlighting and daylighting both within buildings and in the open spaces between them. It is intended to be used in conjunction with the interior daylight recommendations in the British Standard *Code of practice for daylighting*, BS 8206-2. It contains guidance on site layout to provide good natural lighting within a new development; safeguarding of daylight and sunlight within existing buildings nearby; and the protection of daylighting of adjoining land for future development.

A special section deals with site layout for passive solar buildings that use the sun as a source of heating energy. Guidance is also given on the sunlighting of gardens and amenity areas. Issues like privacy, enclosure, microclimate, road layout and security are briefly reviewed. The appendices contain methods to quantify access to sunlight and daylight within a layout.

This guide is a comprehensive revision of the 1991 edition of *Site layout planning for daylight and sunlight: A guide to good practice*. It is purely advisory and the numerical target values within it may be varied to meet the needs of the development and its location. Appendix F explains how this can be done in a logical way, while retaining consistency with the British Standard recommendations on interior daylighting.

Acknowledgements

This guide was produced following an extensive period of consultation with architects, planning officers, consultants, professional institutions and government officials. Special thanks to Joe Lynes and John Basing, who helped to formulate some of the original guidance here, and to Dr Peter Defoe of Calfordseaden LLP who suggested changes to Appendix E Rights to light.

The contributions of all concerned are gratefully acknowledged.



10

HOW TO USE THE GUIDE

Before using this guide, read the Introduction on page 1 which sets out the scope and nature of the guidance.

Summary of content

Terms and definitions

A glossary of terms and definitions used within the guide is on page viii.

Designing for good daylighting and sunlighting within a new development

Refer to Section 2.1 in Section 2 *Light from the sky*, section 3.1 in Section 3 *Sunlighting*, and Appendix C. Section 4 explains how to plan for winter solar heat gain. If there is a conflict with other requirements, Section 5 gives advice.

Protecting the daylighting and sunlighting of existing buildings

See Sections 2.2 and 3.2. Appendix E explains rights to light.

Daylighting of land adjoining a development

This is covered in Section 2.3. Section 3.3 deals with sunlight in gardens and other open spaces between buildings.

Trees and hedges

Appendix H gives guidance on trees and hedges.

Environmental impact assessment

Appendix I explains how to apply the guidance on environmental impact assessment.

The other appendices contain calculation methods and data to help assess the daylighting and sunlighting within a site layout.

GLOSSARY

Average daylight factor (ADF)	Ratio of total daylight flux incident on the working plane to the area of the working plane, expressed as a percentage of the outdoor illuminance on a horizontal plane due to an unobstructed CIE standard overcast sky. Thus a 1% ADF would mean that the average indoor illuminance would be one hundredth the outdoor unobstructed illuminance.
CIE standard overcast sky	<p>A completely overcast sky for which the ratio of its luminance L_γ at an angle of elevation γ above the horizontal to the luminance L_z at the zenith is given by:</p> $L_\gamma = L_z \frac{(1 + 2 \sin \gamma)}{3}$ <p>A CIE standard overcast sky is darkest at the horizon and brightest at the zenith (vertically overhead).</p>
Daylight, natural light	Combined skylight and sunlight.
No sky line	The outline on the working plane of the area from which no sky can be seen.
Obstruction angle	The angular altitude of the top of an obstruction above the horizontal, measured from a reference point in a vertical plane in a section perpendicular to the vertical plane.
Probable sunlight hours	The long-term average of the total number of hours during a year in which direct sunlight reaches the unobstructed ground (when clouds are taken into account).
Sky factor	Ratio of the parts of illuminance at a point on a given plane that would be received directly through unglazed openings from a sky of uniform luminance, to illuminance on a horizontal plane due to an unobstructed hemisphere of this sky. The sky factor does not include reflected light, either from outdoor or indoor surfaces.
Vertical sky component (VSC)	Ratio of that part of illuminance, at a point on a given vertical plane, that is received directly from a CIE standard overcast sky, to illuminance on a horizontal plane due to an unobstructed hemisphere of this sky. Usually the 'given vertical plane' is the outside of a window wall. The VSC does not include reflected light, either from the ground or from other buildings.
Working plane	Horizontal, vertical or inclined plane in which a visual task lies. Normally the working plane may be taken to be horizontal, 0.85 m above the floor in houses and factories, 0.7 m above the floor in offices.

1 INTRODUCTION

1.1 People expect good natural lighting in their homes and in a wide range of non-domestic buildings. Daylight makes an interior look more attractive and interesting as well as providing light to work or read by. Access to skylight and sunlight helps make a building energy efficient; effective daylighting will reduce the need for electric light, while winter solar gain can meet some of the heating requirements.

1.2 The quality and quantity of natural light in an interior depend on two main factors. The design of the interior environment is important: the size and position of windows, the depth and shape of rooms, and the colours of internal surfaces. But the design of the external environment also plays a major role: eg if obstructing buildings are so tall that they make adequate daylighting impossible, or if they block sunlight for much of the year.

1.3 This guide gives advice on site layout planning to achieve good daylighting and sunlighting, within buildings and in the open spaces between them. It is intended to be used in conjunction with the interior daylighting recommendations in BS 8206-2 *Code of practice for daylighting*^[1], and in the CIBSE publication *Lighting guide: daylighting and window design*^[2]. This guide, *Site layout planning for daylight and sunlight: a guide to good practice*, complements them by providing advice on the planning of the external environment. If these guidelines on site layout are followed, along with the detailed window design guidance in BS 8206-2 and *Lighting guide: daylighting and window design*, there is the potential to achieve good daylighting in new buildings, and retain it in existing buildings nearby.

1.4 Other sections in the guide give guidance on site layout for solar energy, on the sunlighting of gardens and amenity areas, and briefly review issues like privacy, enclosure, microclimate, road layout and security. The appendices contain methods to quantify access to sunlight and daylight within a layout.

1.5 This guide supersedes the 1991 edition which is now withdrawn. However, the main aim is the same to help ensure good conditions in the local environment considered broadly, with enough sunlight and daylight on or between the buildings for good interior and exterior conditions.

1.6 The guide is intended for building designers and their clients, consultants and planning officials. The advice given here is not mandatory and the guide should not be seen as an instrument of planning policy; its aim is to help rather than constrain the designer. Although it gives numerical guidelines, these should be interpreted flexibly since natural lighting is only one of many factors in site layout design (see Section 5). In special circumstances the developer or planning authority may wish to use different target values. For example, in a historic city centre, or in an area with modern high rise buildings, a higher degree of obstruction may be unavoidable if new developments are to match the height and proportions of existing buildings. Alternatively, where natural light is of special importance in a building, less obstruction and hence more sunlight and daylight may be deemed necessary. The calculation methods in Appendices A, B and G are entirely flexible in this respect. Appendix F gives advice on how to develop a consistent set of target values for skylight under such circumstances, and Appendix C shows how to relate these to interior daylighting requirements.

1.7 The guidance here is intended for use in the UK and the Republic of Ireland, although many of the principles outlined will apply to other temperate climates. More specific guidance for other locations and climate types is given in a BRE Report *Environmental site layout planning*^[3].

2 LIGHT FROM THE SKY

2.1 NEW DEVELOPMENT

2.1.1 The quantity and quality of daylight inside a room will be impaired if obstructing buildings are large in relation to their distance away. The distribution of light in the room will be affected as well as the total amount received. The guidelines below may be used for dwellings and any non-domestic buildings where daylight is required.

2.1.2 Obstruction can be quantified in a number of ways. The amount of daylight entering a room with a wide obstruction opposite is proportional to the angle of visible sky θ (Greek theta), measured from the centre of the window (Figure 1). This assumes no light comes around the sides of the obstruction. The maximum θ for a vertical window is 90° if there are no obstructions. The average daylight factor (ADF) in a room, which is one basis for the BS 8206-2 recommendations on interior daylighting⁽¹⁾ (see Appendix C), is also proportional to θ .

2.1.3 θ is related to obstruction angle (the angle the obstruction makes from the centre of the window, measured from the horizontal). If we do not count light blocked by the top of the window, θ equals 90° minus the obstruction angle. So the taller and nearer the obstruction, the less light is received.

2.1.4 θ can be hard to estimate if the obstruction is not continuous, or if it projects from the window wall (eg an extension to a house at one side of the window). Good daylighting may still be achievable with a tall obstruction, provided it is not continuous and is narrow enough to allow adequate daylight around its sides. The amount of skylight falling on a vertical wall or window can be quantified as the vertical sky component (VSC) (Figure 2). This is the ratio of the direct sky illuminance falling on the vertical wall at a reference point (usually the centre of the window), to the simultaneous horizontal illuminance under an unobstructed sky. The standard CIE (Commission Internationale de L'Eclairage – International Commission on Illumination) overcast sky is used, and the ratio is usually expressed as a percentage. The maximum value is almost 40% for a completely unobstructed vertical wall. Table C1 in Appendix C gives values of θ equivalent to different VSCs.

2.1.5 VSCs may be calculated using the skylight indicator (Figure A1 in Appendix A) or Waldram diagram (Figure B1 in Appendix B). Note that all obstructing buildings will have an effect, not just those on the site being developed. Appendix H explains the effect of trees and when to include them in the calculation.

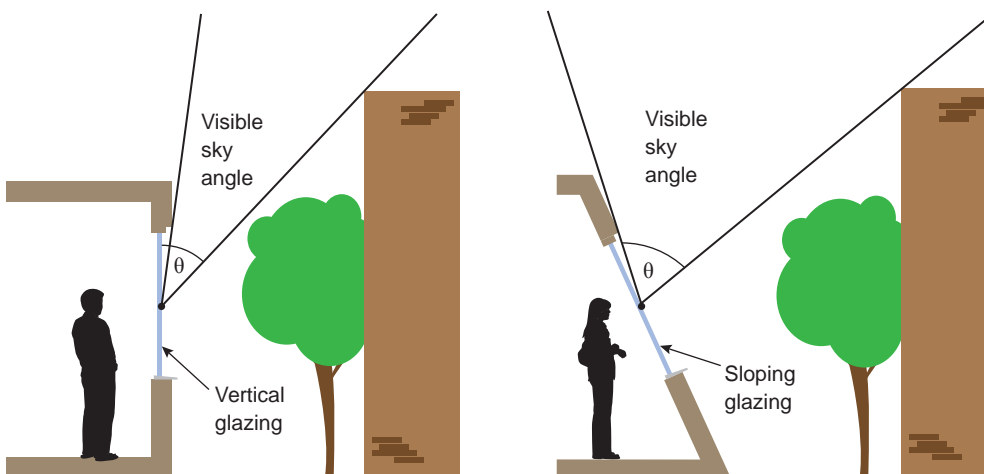

Figure 1: θ is the angle of visible sky measured from the centre of the window, in a vertical plane (section) perpendicular to that of the window

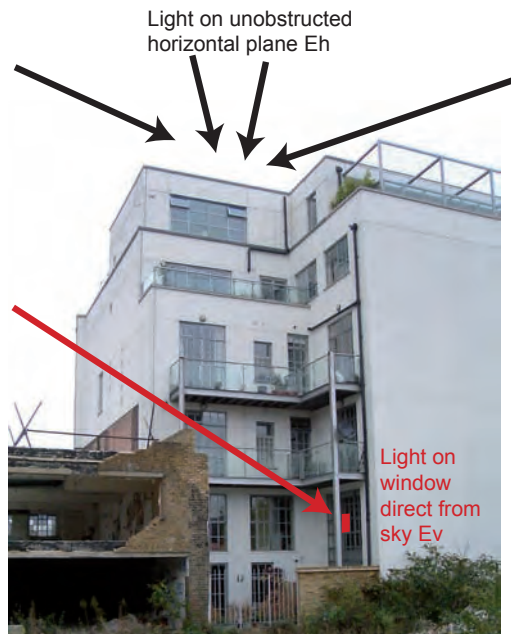

Figure 2: The vertical sky component is the illuminance on the outside of the window, divided by the illuminance on an unobstructed roof, under overcast sky conditions. Reflected light is not included.

2.1.6 The amount of daylight a room needs depends on what it is being used for. But roughly speaking, if θ is:

- greater than 65° (obstruction angle less than 25° or VSC at least 27%) conventional window design will usually give reasonable results
- between 45° and 65° (obstruction angle between 25° and 45° , VSC between 15% and 27%) special measures (larger windows, changes to room layout) are usually needed to provide adequate daylight
- between 25° and 45° (obstruction angle between 45° and 65° , VSC between 5% and 15%) it is very difficult to provide adequate daylight unless very large windows are used
- less than 25° (obstruction angle greater than 65° , VSC less than 5%) it is often impossible to achieve reasonable daylight, even if the whole window wall is glazed.

2.1.7 Where space in a layout is restricted, interior daylighting may be improved in a number of ways. An obvious one is to increase window sizes; the best way to do this is to raise the window head height because this will improve both the amount of daylight entering and its distribution within the room (Figure 3). Raising the window head can be particularly effective for basement windows (Figure 4).

2.1.8 Daylight provision in new rooms may be checked using the average daylight factor (ADF). The ADF is a measure of the overall amount of daylight in a space (Figure 5). BS 8206-2 *Code of practice for daylighting*^[1], recommends an ADF of 5% for a well daylit space and 2% for a partly daylit space. Below 2% the room will look dull and electric lighting is likely to be turned on. In housing BS 8206-2 also gives minimum values of ADF of 2% for kitchens, 1.5% for living rooms and 1% for bedrooms.



Figure 3: In Georgian streets the small spacing-to-height ratio is compensated for by tall windows. Note how window head height increases for the lower floors which are more heavily obstructed.

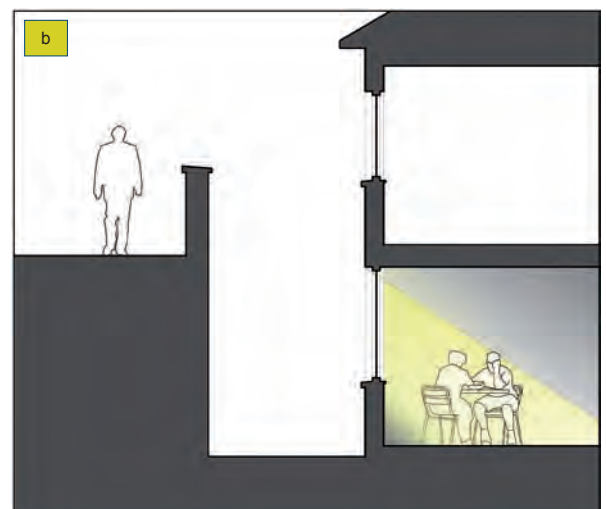
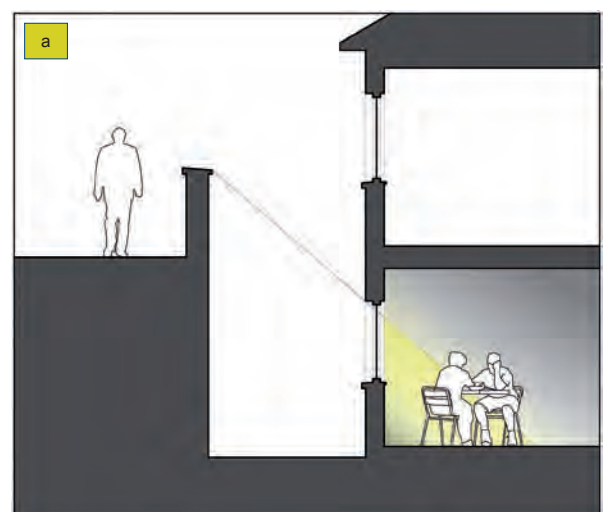

Figure 4: Daylight penetration in a basement (a) is improved by a raised window head (b)

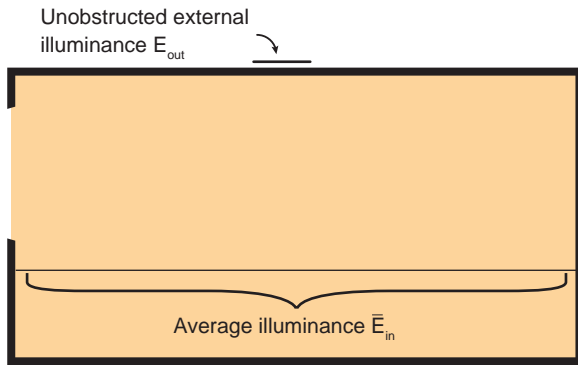

Figure 5: Definition of ADF. Under standard overcast conditions:

$$ADF = \frac{\bar{E}_{in}}{E_{out}} \times 100\%$$

2.1.9 With a higher ADF, indoor daylight will be sufficient for more of the year. So although BS 8206-2 minimum values can be used as targets for daylight in obstructed situations, achieving 2% in living rooms, for instance, will give improved daylight provision, and 3% or 4% would be better still. The higher values would be particularly appropriate in housing for the elderly, because they require more light and are more likely to be at home during the day.

2.1.10 However, interiors with very high ADFs (over 6%) sometimes have problems with summertime overheating or excessive heat loss in winter. Guidance is given in *Reducing overheating: a designers guide*^[4].

2.1.11 Appendix C gives guidance on how to calculate the ADF. Where there are multiple windows, the ADF due to each one can be added together. ADF depends on room reflectances, so having light-coloured room surfaces will increase it, provided these can be kept clean. Appendix H explains how to take into account obstructions caused by trees and hedges.

2.1.12 At the very early stages in design, room layouts and window locations may be undecided. In this situation, one approach is to calculate the VSC at a series of points on each main face of the building 1.6 m above the ground (or lowest storey base) and no more than 5 m apart. Where the VSC is found to change rapidly along a façade it is worthwhile, if possible, to site windows where most daylight is available. This situation often occurs at the internal corners of courtyards or L-shaped blocks. If windows are sited close to these corners they will result in poor levels of daylight as well as potential lack of privacy (Figure 6). Other problem locations include basement windows or those next to a big extension or projection, especially if there are extensions either side of the window (Figure 7).

2.1.13 Living rooms and kitchens need more daylight than bedrooms, so where there is a choice it is best to site the living room or kitchen away from obstructions. Dual storey maisonette-type apartments may be planned with the main living rooms on the upper storey



Figure 6: Windows near internal corners, such as the corners of courtyards, are usually heavily obstructed



Figure 7: A tunnel effect can occur if a window has projecting wings on both sides of it. In this development in South London (architects Broadway Malyan), the windows have been increased in size to compensate.

and the bedrooms on the lower floor for this reason. Areas without a special requirement for daylight, like bathrooms, stairwells, garages and storage areas, can occupy the most obstructed areas such as internal corners of buildings. In mixed use developments commercial uses may occupy the less well daylit areas, allowing residential parts to have better access to light.

2.1.14 Non-daylit internal kitchens should be avoided wherever possible, especially if the kitchen is used as a

dining area too. If the layout means that a small internal galley-type kitchen is inevitable, it should be directly linked to a well daylit living room.

2.1.15 Improving external surface reflectances will also help. Light-coloured building materials (Figure 8) and paving slabs on the ground may be used. However, maintenance of such surfaces should be planned in order to stop them discolouring. And often the benefits may not be as great as envisaged, partly because of ageing of materials and partly for geometrical reasons. The vertical surface of an obstructing building will only receive light from half of the sky. If it is itself obstructed, less skylight will be received and reflected. Thus even if it is light coloured its brightness can never approach that of unobstructed sky. White paints are not perfect reflectors and direct some of the reflected light back upwards. Windows in the obstructing wall act as absorbers, reducing its effective reflectance. Over time, dirt and debris can collect on the wall, darkening it still further, unless it is regularly cleaned and repainted (Figure 9). Any planting, though pleasant to look at, also absorbs light.

2.1.16 Take, for example, a window with a large obstruction in front of it (angle of visible sky θ between 25° and 45°). If the obstruction is painted a light colour (average in use reflectance = 0.5), this is equivalent to increasing θ by only around 6° , in terms of the amount of light received by the window.

2.1.17 Balconies and overhangs significantly reduce the light entering windows below them (Figure 10). This is a particular problem if there are large obstructions opposite; with the combined effect of the overhang and the obstruction, it may be impossible to see the sky from inside the room, and hence to receive any direct skylight or sunlight at all. Although a balcony is often a pleasant amenity, in a heavily obstructed situation the balcony is usually less valued because it may lack privacy and receive little sun.

2.1.18 There are various techniques to minimise the effect of balconies and overhangs such as access decks. Glazing in the balcony, and making the resulting enclosed area part of the living room, gives a private internal space that can still receive daylight and sunlight. This is beneficial in obstructed ground floor rooms; otherwise, ground floor occupants are obstructed by the balcony above without having a balcony area of their own. Depending on the layout of the building, sometimes the façade can be stepped back to allow rooftop access or terraced gardens, without creating an overhang to the windows below (Figure 11).

2.1.19 Alternatively balconies may be staggered, so that a living room has its own balcony, but not one directly above it (Figures 12 and 13). Bathrooms or, in less obstructed situations, bedrooms could be sited underneath the balcony.



Figure 8: A white finish to external walls, as in this North London development (architects Sheppard Robson), can increase reflected light. However, windows will tend to reduce the overall effective reflectance.



Figure 9: White walls require regular maintenance or their reflectance will deteriorate, as shown here

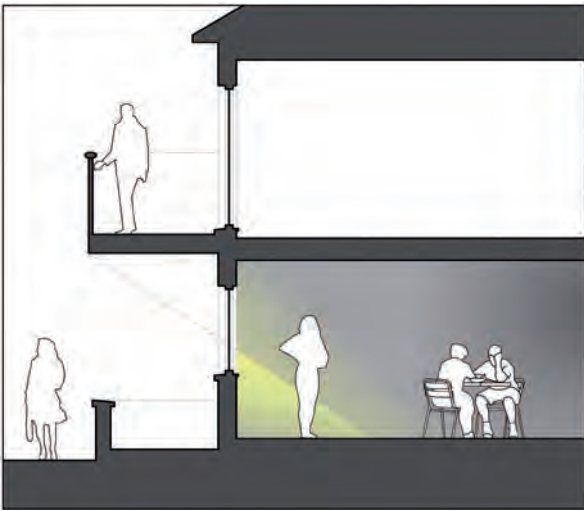

Figure 10: Balconies and projecting access ways can restrict daylight to rooms lit by windows below them

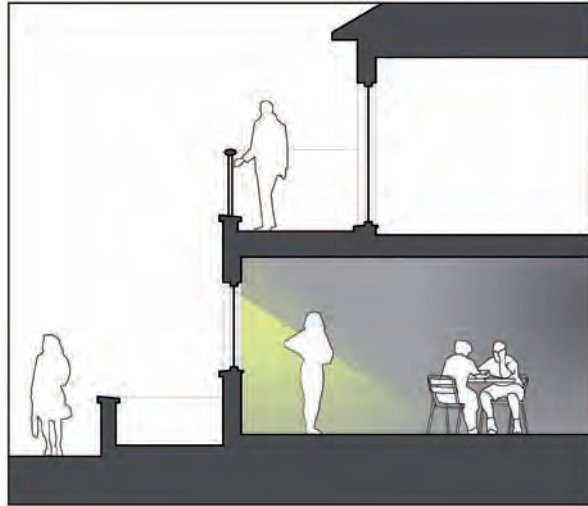

Figure 11: Section showing stepped back rooftop access ways. This gives improved daylight compared to a conventional section (see Figure 10).

2.1.20 Finally, one important way to plan for good interior daylight is to reduce building depth (window wall to window wall). Even on a totally unobstructed site there is still a limit to how deep a room can be and still remain properly daylight. The presence of obstructions may reduce this limiting depth still further. Appendix C gives details of how to calculate these limiting room depths for good daylighting.

Summary

2.1.21 Obstructions can limit access to light from the sky. This can be checked by measuring or calculating the angle of visible sky θ , angle of obstruction or vertical sky component (VSC) at the centre of the lowest window where daylight is required. If VSC is:

- at least 27% (θ is greater than 65° , obstruction angle less than 25°) conventional window design will usually give reasonable results.
- between 15% and 27% (θ is between 45° and 65° , obstruction angle between 25° and 45°) special measures (larger windows, changes to room layout) are usually needed to provide adequate daylight.
- between 5% and 15% (θ is between 25° and 45° , obstruction angle between 45° and 65°) it is very difficult to provide adequate daylight unless very large windows are used.
- less than 5% (θ less than 25° , obstruction angle more than 65°) it is often impossible to achieve reasonable daylight, even if the whole window wall is glazed.

2.1.22 To check that adequate daylight is provided in new rooms, the ADF may be calculated and compared with the recommendations in BS 8206-2 *Code of practice for daylighting*⁽¹⁾ (see Appendix C).

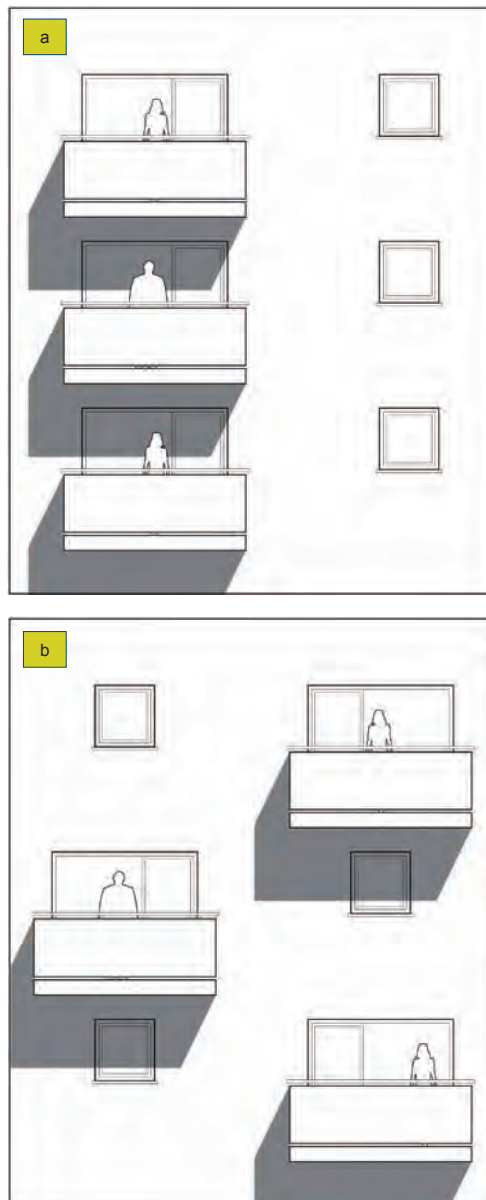

Figure 12: In a conventional layout (a) the balcony above each living room reduces the daylight it receives. Staggered balconies (elevation b) give improved daylight and sunlight to living rooms.



Figure 13: This North London development (architects CZWG) has staggered balconies to minimise obstruction to living rooms. Where a balcony is above a living room the obstructed area has been modified to form an unobstructed bay window.

2.2 EXISTING BUILDINGS

2.2.1 In designing a new development or extension to a building, it is important to safeguard the daylight to nearby buildings. A badly planned development may make adjoining properties gloomy and unattractive.

2.2.2 The guidelines given here are intended for use for rooms in adjoining dwellings where daylight is required, including living rooms, kitchens and bedrooms. Windows to bathrooms, toilets, storerooms, circulation areas and garages need not be analysed. The guidelines may also be applied to any existing non-domestic building where the occupants have a reasonable expectation of daylight; this would normally include schools, hospitals, hotels and hostels, small workshops and some offices.

2.2.3 Note that numerical values given here are purely advisory. Different criteria may be used based on the requirements for daylighting in an area viewed against other site layout constraints. Another important issue is whether the existing building is itself a good neighbour, standing a reasonable distance from the boundary and taking no more than its fair share of light. Appendix F gives further guidance.

2.2.4 Loss of light to existing windows need not be analysed if the distance of each part of the new development from the existing window is three or more times its height above the centre of the existing window. In these cases the loss of light will be small. Thus if the new development were 10 m tall, and a typical existing ground floor window would be 1.5 m above the ground, the effect on existing buildings more than $3 \times (10 - 1.5) = 25.5$ m away need not be analysed.

2.2.5 If the proposed development is taller or closer than this, a modified form of the procedure adopted for new buildings can be used to find out whether an existing building still receives enough skylight. First, draw a section in a plane perpendicular to each affected main window wall of the existing building (Figure 14). Measure the angle to the horizontal subtended by the new development at the level of the centre of the lowest window. If this angle is less than 25° for the whole of the development then it is unlikely to have a substantial effect on the diffuse skylight enjoyed by the existing building. If, for any part of the new development, this angle is more than 25° , a more detailed check is needed to find the loss of skylight to the existing building. Both the total amount of skylight and its distribution within the building are important.

2.2.6 Any reduction in the total amount of skylight can be calculated by finding the VSC at the centre of each main window. In the case of a floor-to-ceiling window such as a patio door, a point 1.6 m above ground (or balcony level for an upper storey) on the centre line of the window may be used. For a bay window, the centre window facing directly outwards can be taken as the main window. If a room has two or more windows of equal size, the mean of their VSCs may be taken. The reference point is in the external plane of the window wall. Windows to bathrooms, toilets, storerooms, circulation areas and garages need not be analysed. The VSC can be found by using the skylight indicator (Figure A1 in Appendix A) or Waldram diagram (Figure B1 in Appendix B), or appropriate computer software.

2.2.7 If this VSC is greater than 27% then enough skylight should still be reaching the window of the existing building. Any reduction below this level should be kept to a minimum. If the VSC, with the new development in place, is both less than 27% and less than 0.8 times its former value, occupants of the existing building will notice the reduction in the amount of skylight. The area lit by the window is likely to appear more gloomy, and electric lighting will be needed more of the time.

2.2.8 Where room layouts are known, the impact on the daylighting distribution in the existing building can be found by plotting the 'no sky line' in each of the main rooms. For houses this would include living rooms, dining rooms and kitchens; bedrooms should also be analysed although they are less important. In non-domestic buildings each main room where daylight is expected should be investigated. The no sky line divides points on the working plane which can and cannot see the sky (Figure 15). (In houses the working plane is assumed to be horizontal and 0.85 m high; in offices 0.7 m high; in special interiors like hospital wards and infant school classrooms a different height may be appropriate.) Areas beyond the no sky line, since they receive no direct daylight, usually look dark and gloomy compared with the rest of the room, however bright it is outside. According to BS 8206-2⁽¹⁾, supplementary electric lighting will be

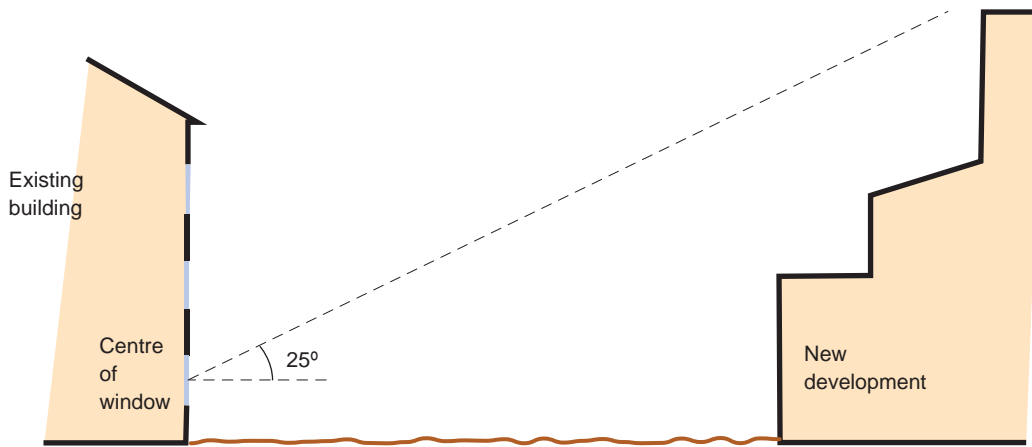

Figure 14: Section in plane perpendicular to the affected window wall

needed if a significant part of the working plane lies beyond the no sky line. Appendix D gives hints on how to plot the no sky line.

2.2.9 If, following construction of a new development, the no sky line moves so that the area of the existing room, which does receive direct skylight, is reduced to less than 0.8 times its former value this will be noticeable to the occupants, and more of the room will appear poorly lit. This is also true if the no sky line encroaches on key areas like kitchen sinks and worktops.

2.2.10 The guidelines above need to be applied sensibly and flexibly. There is little point in designing tiny gaps in the roof lines of new development in order to safeguard no sky lines in existing buildings. If an existing building contains rooms lit from one side only and greater than 5 m deep, then a greater movement of the no sky line may be unavoidable.

2.2.11 Existing windows with balconies above them typically receive less daylight. Because the balcony cuts out light from the top part of the sky, even a modest

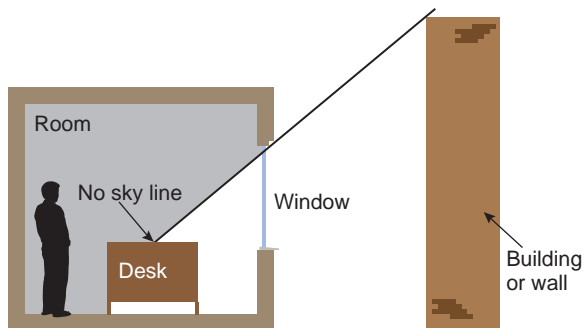

Figure 15: The no sky line divides areas of the working plane which can and cannot receive direct skylight

obstruction opposite may result in a large relative impact on the VSC, and on the area receiving direct skylight. One way to demonstrate this would be to carry out an additional calculation of the VSC and area receiving direct skylight, for both the existing and proposed situations, without the balcony in place. For example, if the proposed VSC with the balcony was under 0.8 times the existing value with the balcony, but the same ratio for the values without the balcony was well over 0.8, this would show that the presence of the balcony, rather than the size of the new obstruction, was the main factor in the relative loss of light.

2.2.12 A larger relative reduction in VSC may also be unavoidable if the existing window has projecting wings on one or both sides of it, or is recessed into the building so that it is obstructed on both sides as well as above.

2.2.13 However, as a general rule the aim should be to minimise the impact to the existing property. This is particularly important where successive extensions are planned to the same building. In this case the total impact on skylight due to all the extensions needs to be calculated and compared with the guidance above.

2.2.14 For domestic extensions which adjoin the front or rear of a house, a quick method can be used to assess the diffuse skylight impact on the house next door. It only applies where the nearest side of the extension is perpendicular to the window (Figure 16); it is not valid for windows which directly face the extension, or for buildings opposite. For these cases the guidelines above should be used.

2.2.15 Figure 17 illustrates the application of the method, the '45° approach'. Take the elevation of the window wall and draw diagonally down at an angle of 45° away from the near top corner of the extension (Figure 17). If the extension has a pitched roof then the top of the extension can be taken as the height of its roof halfway along the slope (Figure 18). Then take the plan and draw diagonally back at an angle of 45° towards

the window wall from the end of the extension. (Note that the section perpendicular to the window is not used here.) If the centre of a main window of the next door property lies on the extension side of both these 45° lines then the extension may well cause a significant reduction in the skylight received by the window. (In the case of a floor-to-ceiling window such as a patio door, a point 1.6 m above the ground on the centre line of the window may be used.)

2.2.16 Like most rules of thumb, this one needs to be interpreted flexibly. For example, if the extension has another extension, or a much larger building, behind it then the daylight from that direction may be blocked anyway. Special care needs to be taken in cases where an extension already exists on the other side of the window, to avoid a 'tunnel effect' (Figure 19). A VSC calculation (see Sections 2.2.5 and 2.2.6) can be used to quantify the loss of light, if required.

2.2.17 Finally, as with the other guidelines in this section, the 45° approach deals with diffuse skylight only. Additional checks will need to be made for the sunlight which may be blocked (see Section 3.2).

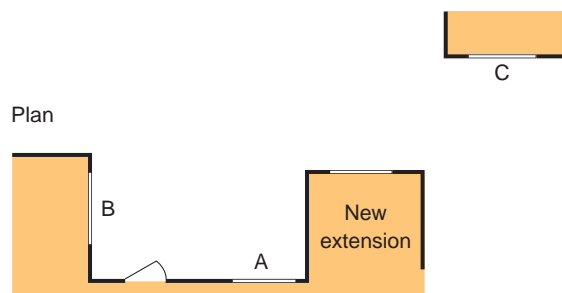

Figure 16: To assess the impact of the new extension, the 45° approach may be used for window A but not for windows B and C which directly face it

2.2.18 The windows of some existing buildings may also have a right to light^[5] (see Appendix E). None of the guidelines here is intended to replace, or be a means of satisfying, the legal requirements in the law surrounding the right to light. The assessment of loss of light in rights of light cases is carried out in a different way to the methods given in this BRE guide. It should not be assumed that if the guidelines given here are satisfied then a new development will not infringe rights to light, or vice versa. If an existing building does have a right to light, then it would be prudent for the designer of the new development to check that it does not infringe that right.

2.2.19 It is not always apparent whether a right to light exists, but any window in a building older than 20 years should be assumed to have acquired a right under the Prescription Act 1832, in the absence of evidence to the contrary. The advice of a specialist consultant, and possibly a lawyer, may be needed. Appendix E gives further details.

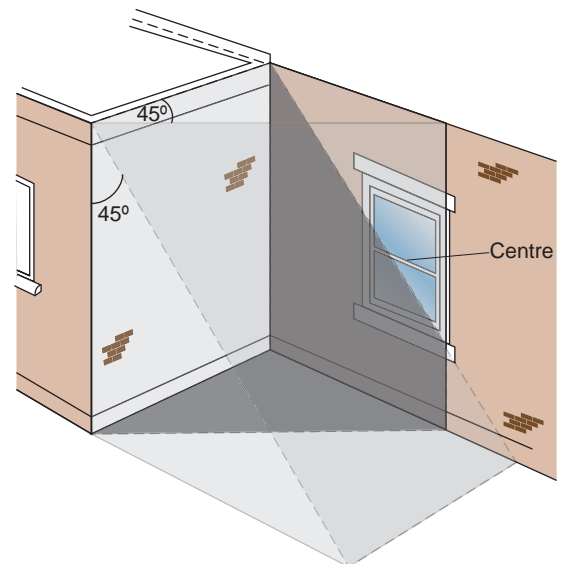
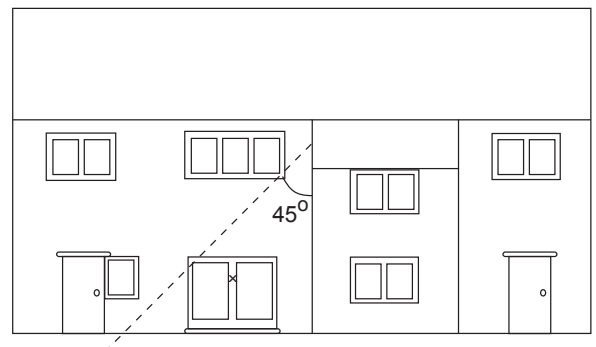

Figure 17: Application of the 45° approach to a domestic extension. A significant amount of light is likely to be blocked if the centre of the window lies within the 45° angle on both plan and elevation. Here the centre of the window lies outside the 45° angle on elevation, so the impact of the extension is likely to be small.

Section



Plan

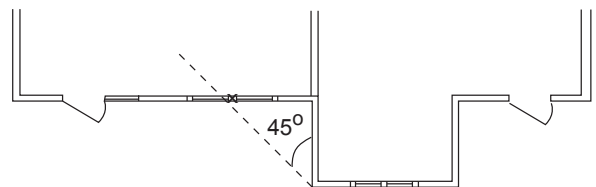

Figure 18: Here the extension has a pitched roof, so a point halfway along the roof slope is used as the start of the 45° line on the elevation. The affected window is a patio door, so a point 1.6 m above the ground has been taken. This point is within the 45° angles on both plan and elevation, so a significant reduction of light is likely.

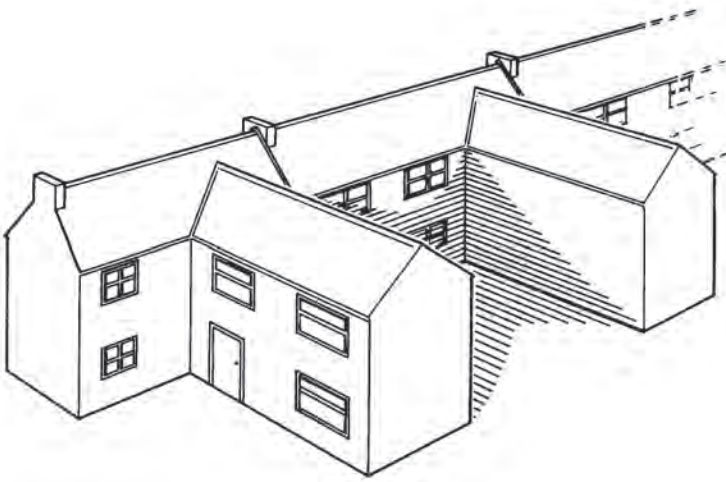

Figure 19: A tunnel effect can occur if a window is obstructed by extensions on both sides

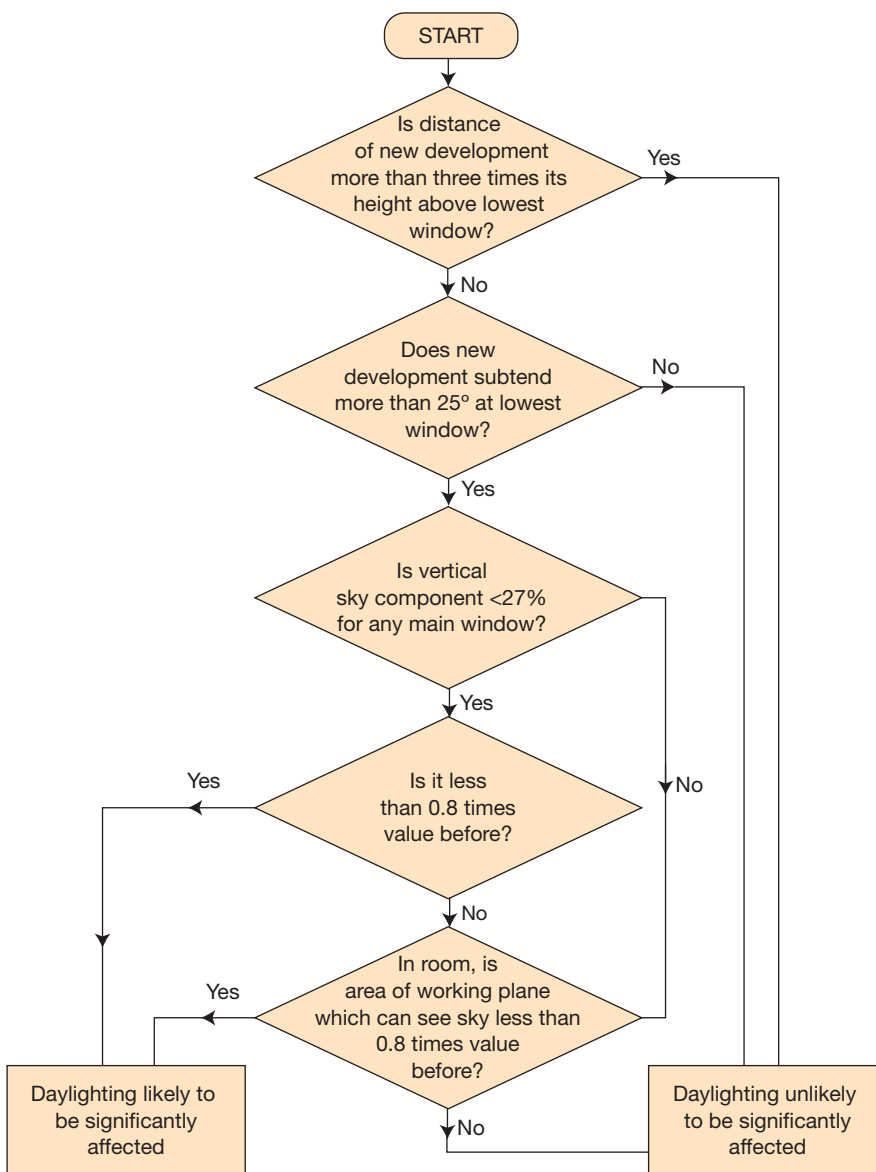

Figure 20: Decision chart: diffuse daylight in existing buildings. This does not include an assessment of rights to light issues, which a developer may need to consider separately.

2.2.20 Obstruction of light from the sky is just one of the ways in which a new development can affect existing buildings nearby. The obstruction of sunlight is also important (see Sections 3.2 and 3.3) as are questions of view and privacy (see Section 5).

Summary (Figure 20)

2.2.21 If any part of a new building or extension, measured in a vertical section perpendicular to a main window wall of an existing building, from the centre of the lowest window, subtends an angle of more than 25° to the horizontal, then the diffuse daylighting of the existing building may be adversely affected. This will be the case if either:

- the VSC measured at the centre of an existing main window is less than 27%, and less than 0.8 times its former value
- the area of the working plane in a room which can receive direct skylight is reduced to less than 0.8 times its former value.

2.3 ADJOINING DEVELOPMENT LAND

2.3.1 From a daylighting standpoint it is possible to reduce the quality of adjoining development land by building too close to the boundary. A well designed building will stand a reasonable distance back from the boundaries so as to enable future nearby developments to enjoy a similar access to daylight. By doing so it will also keep its own natural light when the adjoining land is developed.

2.3.2 This applies to future non-domestic development as well as housing. However, it does not apply when no main window wall, either of the current new development or of any probable future development on the adjoining site, will face over the boundary. Thus the guidance below is not applicable for a boundary next to a windowless flank wall of a new house where any future housing next door should also present a flank wall without windows; nor need it apply to an industrial estate where new development and any future development is either windowless or solely rooflit.

2.3.3 The diffuse daylight coming over the boundary may be quantified in the following way. As a first check, draw a section in a plane perpendicular to the boundary (Figure 21). If a road separates the two sites then the centre line of the road should be taken. Measure the angle to the horizontal subtended at a point 1.6 m above the boundary by the proposed new buildings. If this angle is less than 43° then there will normally still be the potential for good daylighting on the adjoining development site (but see Sections 2.3.6 and 2.3.7).

2.3.4 If any of the new buildings is taller than this, enough skylight may still reach the development site provided the building is narrow enough to allow adequate light around its sides. This may be quantified by calculating the VSC (see Section 2.1) at a series of points 1.6 m above the boundary and facing towards the proposed new buildings. Here only obstructions caused by the proposed new buildings need to be taken into account. This contrasts with the calculations for buildings where all obstructions need to be included in the analysis. VSCs may be found using the skylight indicator (Figure A1 in Appendix A) or Waldram diagram (Figure B1 in Appendix B), or by appropriate computer software.

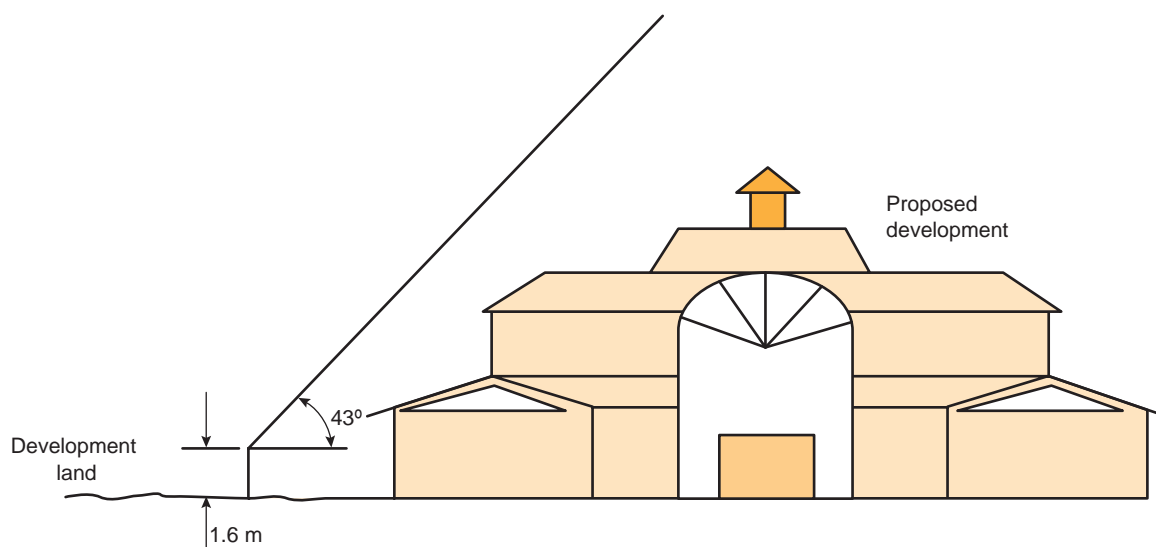

Figure 21: Angular criterion for overshadowing of future development land (on left)

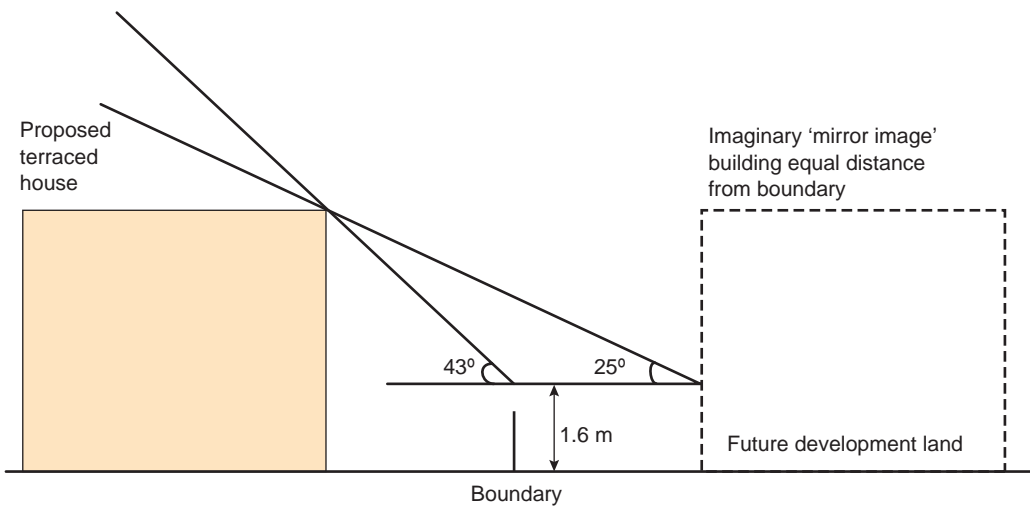

Figure 22: Derivation of an angular boundary criterion to safeguard future development of adjoining land

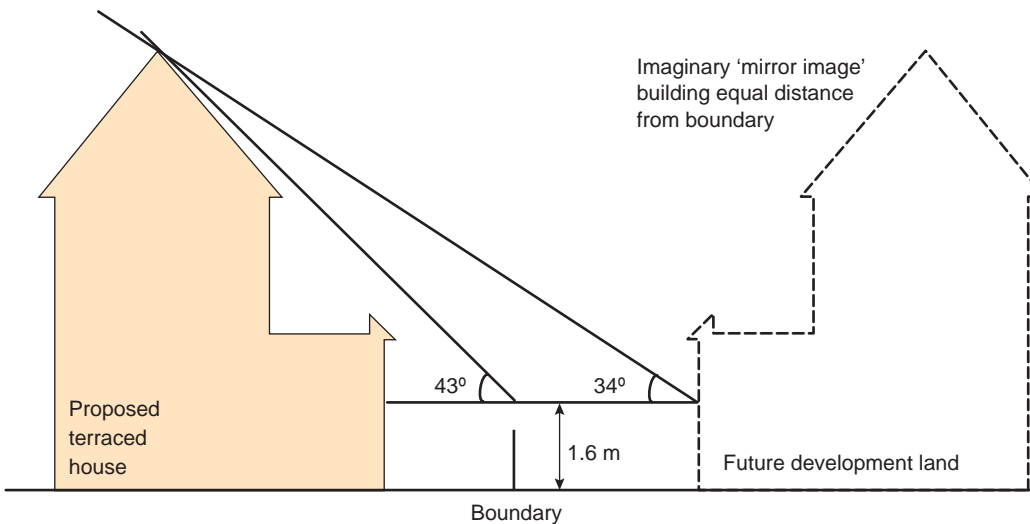

Figure 23: Problems with the boundary criterion can occur when a stepped façade overlooks adjoining land

2.3.5 Overall the adjoining development site should normally retain the potential for good daylighting if every point 1.6 m above the boundary line is within 4 m (measured along the boundary) of a point with a VSC of 17% or more. This corresponds to the value for a continuous obstruction subtending the 43° angle above.

2.3.6 The guidelines above should not be applied too rigidly. A particularly important exception occurs when the two sites are very unequal in size and the proposed new building is larger in scale than the likely future development nearby. This is because the numerical values above are derived by assuming the future development will be exactly the same size as the proposed new building (Figure 22). If the adjoining sites for development are a lot smaller, a better approach is to make a rough prediction of where the nearest window wall of the future development may be; then to carry out the 'new building' analysis in Section 2.1 for this window wall.

2.3.7 The 43° angle should not be used as a form generator, to produce a building which slopes or steps down towards the boundary. Compare Figure 23 with Figure 22 to see how this can result in a higher than anticipated obstruction to daylight. In Figure 23 the proposed building subtends 34° at its mirror image, rather than the maximum of 25° suggested here. In cases of doubt, the best approach is again to carry out a new building analysis for the most likely location of a window wall of a future development.

2.3.8 The numerical values quoted above are purely advisory. Different values may be used depending on the type of development earmarked for the adjoining land. All the calculation methods are flexible in this respect. Table F1 in Appendix F gives the VSCs which correspond to different obstruction angles at the boundary, and relates the boundary values to those for faces of buildings to ensure self consistency.

2.3.9 For simplicity, no numerical guidance is given on sunlighting of land for future development. However, a proposed building or group of buildings can significantly reduce the sunlighting of an adjoining site. If this is likely to be a problem, a good way to assess it is to draw the shadows cast by the new buildings at different times of the year. Section 3.3 gives details.

Summary

2.3.10 In broad general terms (taking into account the exceptions above), a development site next to a proposed new building will retain the potential for good diffuse daylighting provided that on each common boundary:

- (a) no new building, measured in a vertical section perpendicular to the boundary, from a point 1.6 m above ground level, subtends an angle of more than 43° to the horizontal
- (b) or, if (a) is not satisfied, then all points 1.6 m above the boundary line are within 4 m (measured along the boundary) of a point which has a VSC (looking towards the new building(s)) of 17% or more.

3 SUNLIGHTING

3.1 NEW DEVELOPMENT

3.1.1 People like sunlight. In surveys^[6] around 90% said they appreciated having sunlight in their homes. The sun is seen as providing light and warmth, making rooms look bright and cheerful and also having a therapeutic, health giving effect.

3.1.2 In housing, the main requirement for sunlight is in living rooms, where it is valued at any time of day but especially in the afternoon. Sunlight is also required in conservatories. It is viewed as less important in bedrooms and in kitchens, where people prefer it in the morning rather than the afternoon.

3.1.3 Sunlight is also valued in non-domestic buildings. However, the requirement for sunlight will vary according to the type of non-domestic building, the aims of the designer and the extent to which the occupants can control their environment. People appreciate sunlight more if they can choose whether or not to be exposed to it, either by changing their positions in the room or using adjustable shading. Where prolonged access to sunlight is available, shading devices will also be needed to avoid overheating and unwanted glare from the sun. This can apply to housing as well (Figure 24). BRE Report *Solar shading of buildings*^[7] gives recommendations. Shading provision should be based on the need for it; there is no point in having large overhangs or louvres to windows that receive little or no sun, and they can restrict daylight from entering the room.

3.1.4 In the winter, solar heat gain can be a valuable resource, reducing the need for space heating. Good design can make the most of this. This aspect of sunlight provision is dealt with in Section 4; here we concentrate on the amenity aspects of sunlight.

3.1.5 Site layout is the most important factor affecting the duration of sunlight in buildings. It can be divided into two main issues, orientation and overshadowing.

Orientation

3.1.6 A south-facing window will, in general, receive most sunlight, while a north-facing one will only receive it on a handful of occasions (early morning and late evening in summer). East- and west-facing windows will receive



Figure 24: In this housing association scheme, solar shading is provided by balconies and overhangs

sunlight only at certain times of the day. A dwelling with no main window wall within 90° of due south is likely to be perceived as insufficiently sunlit. This is usually only an issue for flats. Sensitive layout design of flats will attempt to ensure that each individual dwelling has at least one main living room which can receive a reasonable amount of sunlight. In both flats and houses, a sensible approach is to try to match internal room layout with window wall orientation. Where possible, living rooms should face the southern or western parts of the sky and kitchens towards the north or east.

3.1.7 The overall sunlighting potential of a large residential development may be initially assessed by counting how many dwellings have a window to a main living room facing south, east or west. The aim should be to minimise the number of dwellings whose living rooms face solely north, north east or north west, unless there is some compensating factor such as an appealing view to the north.

3.1.8 Figure 25 shows an example of flats where the main living rooms are arranged to face the southern part of the sky. For larger developments of flats, especially those with site constraints, it may not be possible to have every living room facing within 90° of south. However, this can be improved using the following techniques:

- Having access ways and corridors on the north side, and living room windows on the south side.
- Where flats are grouped on both sides of a central corridor, having ancillary areas such as stairwells, lift



Figure 25: Flats with south-facing living rooms

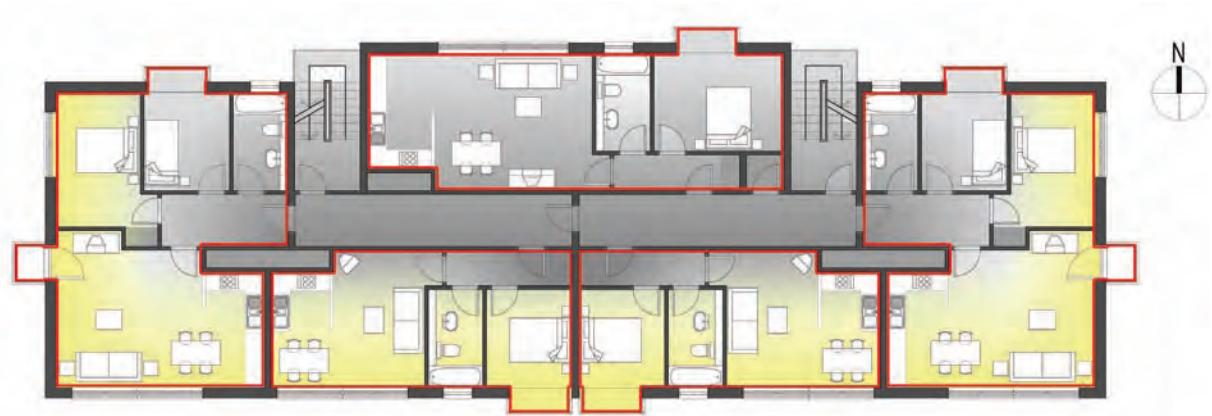

Figure 26: Careful layout design means that four out of the five flats shown have a south-facing living room

cores and bicycle storage on the north side of the building. Figure 26 shows an example where the majority of flats have a south-facing living room.

- Arranging the flats so that living rooms are placed at the end corners of the building and hence can be dual aspect. That way, living rooms on the north side of the building can also have an east- or west-facing window which can receive some sun.
- Alternatively, arranging the flats with a long north–south axis so that living room windows face east and west, and can all receive some sun.

Overshadowing

3.1.9 The overall access to sunlight of a new development can be considerably enhanced if the layout of new buildings is designed with care so that they overshadow each other as little as possible. At a simple level, access to sunlight can be improved by:

- choosing a site on a south-facing slope, if possible, rather than a north-facing one
- having taller buildings to the north of the site with low-rise buildings to the south, but care must be taken not to overshadow neighbouring property (Section 3.2)
- having low density housing (semi-detached and detached) at the southern end of a site, with terraced housing to the north
- placing terraces on east–west roads (so that one window wall faces nearly south) and semi-detached and detached houses on north–south roads
- opening out courtyards to the southern half of the sky
- having garages to the north of houses
- avoiding obstructions to the south such as protruding extensions or other buildings, where window walls face predominantly east or west
- having low pitched roofs on housing.

3.1.10 For interiors, access to sunlight can be quantified. BS 8206-2^[1] recommends that interiors where the occupants expect sunlight should receive at least one quarter (25%) of annual probable sunlight hours (APSH), including in the winter months between 21 September and 21 March at least 5% of APSH. Here 'probable sunlight hours' means the total number of hours in the year that the sun is expected to shine on unobstructed ground, allowing for average levels of cloudiness for the location in question. One of the sunlight availability indicator in Appendix A (Figures A2, A3 or A4) can be used to calculate hours of sunlight received.

3.1.11 The BS 8206-2 criterion applies to rooms of all orientations, although if a room faces significantly north of due east or west it is unlikely to be met.

3.1.12 If window positions are already known, the centre of each main living room window can be used for the calculation. In the case of a floor-to-ceiling window such as a patio door, a point 1.6 m above ground on the centre line of the window may be used. In accordance with the recommendation in BS 8206-2, a point on the inside face of the window wall should be taken. Sunlight blocked by the window reveals should not be included, but the effect of the window frames in blocking sunlight need not be taken into account. If a room has multiple windows on the same wall or on adjacent walls, the highest value of APSH should be taken. If a room has two windows on opposite walls, the APSH due to each can be added together.

3.1.13 At the site layout stage the positions of windows may not have been decided. It is suggested that sunlight availability be checked at points 1.6 m above the ground or lowest storey level on each main window wall, and no more than 5 m apart. If the access to sunlight changes rapidly along a façade it is worthwhile trying to site main windows, particularly of living rooms, where most sunlight is available.

3.1.14 The BS 8206-2 criterion is intended to give good access to sunlight in a range of situations. However, in special circumstances the designer or planning authority may wish to choose a different target value for hours of sunlight. If sunlight is particularly important in a building, a higher target value may be chosen, although the risk of overheating needs to be borne in mind. Section 4 gives guidance on passive solar design. Conversely, if in a particular development sunlight is deemed to be less important but still worth checking for, a lower target value could be used. In either case, the sunlight availability indicators in Appendix A will still show whether the hours of sunlight received meet the target.

3.2 EXISTING BUILDINGS

3.2.1 In designing a new development or extension to a building, care should be taken to safeguard the access to sunlight both for existing dwellings, and for any

Summary (new buildings)

3.1.15 In general a dwelling, or non-domestic building which has a particular requirement for sunlight, will appear reasonably sunlit provided:

- at least one main window wall faces within 90° of due south and
- the centre of at least one window to a main living room can receive 25% of annual probable sunlight hours, including at least 5% of annual probable sunlight hours in the winter months between 21 September and 21 March.

3.1.16 Where groups of dwellings are planned, site layout design should aim to maximise the number of dwellings with a main living room that meets the above recommendations.

nearby non-domestic buildings where there is a particular requirement for sunlight. People are particularly likely to notice a loss of sunlight to their homes and if it is extensive then it will usually be resented.

3.2.2 Obstruction to sunlight may become an issue if:

- some part of a new development is situated within 90° of due south of a main window wall of an existing building (Figure 27)
- in the section drawn perpendicular to this existing window wall, the new development subtends an angle greater than 25° to the horizontal measured from the centre of the lowest window to a main living room (Figure 14).

3.2.3 To assess loss of sunlight to an existing building, it is suggested that all main living rooms of dwellings, and conservatories, should be checked if they have a window facing within 90° of due south. Kitchens and bedrooms are less important, although care should be taken not to block too much sun. In non-domestic buildings any spaces which are deemed to have a special requirement for sunlight should be checked; they will normally face within 90° of due south anyway.

3.2.4 A point at the centre of the window on the outside face of the window wall may be taken. In the case of a floor-to-ceiling window such as a patio door, a point on the centre line of the window 1.6 m above the ground (or balcony level in the case of an upper storey window) may be used, again on the plane of the outside surface of the wall. If the main living room to a dwelling has a main window facing within 90° of due north, but a secondary window facing within 90° of due south, sunlight to the secondary window should be checked.

3.2.5 If this window point can receive more than one quarter of APSH (see section 3.1), including at least 5% of APSH in the winter months between 21 September and 21 March, then the room should still receive enough

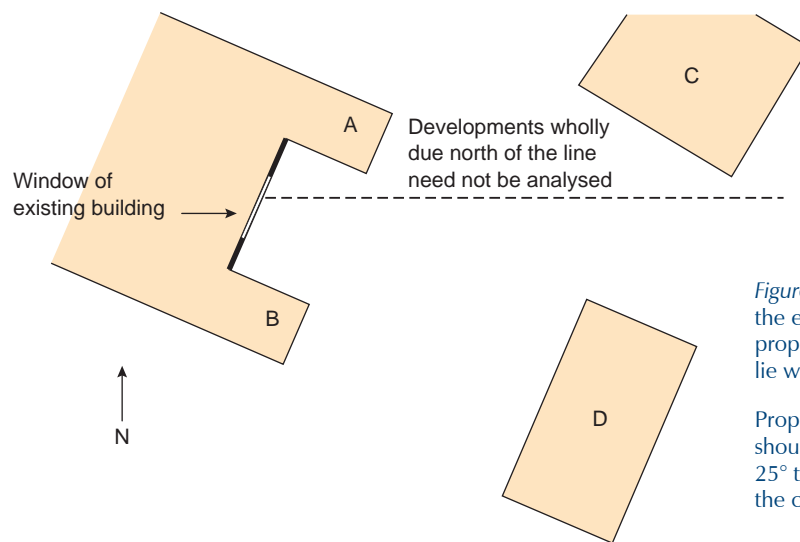

Figure 27: In analysing the sunlighting impact on the existing window, no check need be made for proposed extension A and new building C, as they lie within 90° of due north of the window.

Proposed extension B should be checked, as should new building D if it subtends more than 25° to the horizontal, measured in section from the centre of the window.

sunlight. The sunlight availability indicators (Figures A2, A3 and A4) in Appendix A can be used to check this.

3.2.6 Any reduction in sunlight access below this level should be kept to a minimum. If the available sunlight hours are both less than the amount above and less than 0.8 times their former value, either over the whole year or just in the winter months (21 September to 21 March), then the occupants of the existing building will notice the loss of sunlight; if the overall annual loss is greater than 4% of APSH, the room may appear colder and less cheerful and pleasant.

3.2.7 It is not always necessary to do a full calculation to check sunlight potential. The guideline above is met provided either of the following is true:

- If the distance of each part of the new development from the existing window is three or more times its height above the centre of the existing window (NB obstructions within 90° of due north of the existing window need not count here).
- The window wall faces within 90° of due south and no obstruction, measured in the section perpendicular to the window wall, subtends an angle of more than 25° to the horizontal (Figure 14 in Section 2.2). Again, obstructions within 90° of due north of the existing window need not be counted.
- The window wall faces within 20° of due south and the reference point has a VSC (section 2.1) of 27% or more.

3.2.8 In certain situations care needs to be taken in applying these guidelines. For example if the proposed new development is one of a number of successive extensions to the same building then the total impact on sunlight due to all the extensions should be assessed. On the other hand, if the existing building stands unusually close to the common boundary with the new development, or has a large balcony or overhang above the window, then a greater reduction in sunlight access may be unavoidable. The guidelines are purely advisory. Planning authorities may wish to use different criteria based on the requirements for sunlight in particular

types of developments in particular areas. Sometimes a larger reduction in sunlight may be necessary if new development is to match the height and proportion of existing buildings nearby.

3.2.9 Balconies and overhangs above an existing window tend to block sunlight, especially in summer. Even a modest obstruction opposite may result in a large relative impact on the sunlight received. One way to demonstrate this would be to carry out an additional calculation of the APSH, for both the existing and proposed situations, without the balcony in place. For example, if the proposed APSH with the balcony was under 0.8 times the existing value with the balcony, but the same ratio for the values without the balcony was well over 0.8, this would show that the presence of the balcony, rather than the size of the new obstruction, was the main factor in the relative loss of sunlight.

3.2.10 It is good practice to check the sunlighting of gardens of existing buildings. This is described in Section 3.3.

Summary

3.2.11 If a living room of an existing dwelling has a main window facing within 90° of due south, and any part of a new development subtends an angle of more than 25° to the horizontal measured from the centre of the window in a vertical section perpendicular to the window, then the sunlighting of the existing dwelling may be adversely affected. This will be the case if the centre of the window:

- receives less than 25% of annual probable sunlight hours, or less than 5% of annual probable sunlight hours between 21 September and 21 March and
- receives less than 0.8 times its former sunlight hours during either period and
- has a reduction in sunlight received over the whole year greater than 4% of annual probable sunlight hours.

3.3 GARDENS AND OPEN SPACES

3.3.1 Good site layout planning for daylight and sunlight should not limit itself to providing good natural lighting inside buildings. Sunlight in the spaces between buildings has an important impact on the overall appearance and ambience of a development. It is valuable for a number of reasons, to:

- provide attractive sunlit views (all year)
- make outdoor activities like sitting out and children's play more pleasant (mainly warmer months)
- encourage plant growth (mainly spring and summer)
- dry out the ground, reducing moss and slime (mainly in colder months)
- melt frost, ice and snow (in winter)
- dry clothes (all year).

3.3.2 The sunlit nature of a site can be enhanced by using some of the techniques described in Section 3.1. This could include siting low rise, low density housing to the south, with taller, higher density housing to the north of a site; and by opening out courtyards to the southern half of the sky. Special care needs to be taken in the design of courtyards as often they can turn out to be sunless and unappealing.

3.3.3 The availability of sunlight should be checked for all open spaces where it will be required. This would normally include:

- gardens, usually the main back garden of a house
- parks and playing fields
- children's playgrounds
- outdoor swimming pools and paddling pools
- sitting out areas such as those between non-domestic buildings and in public squares
- focal points for views such as a group of monuments or fountains.

3.3.4 Each of these spaces will have different sunlighting requirements and it is difficult to suggest a hard and fast rule. However, it is clear that the worst situation is to have significant areas on which the sun only shines for a limited period over a large part of the year (Figure 28). The equinox (21 March) can be chosen as a date for assessment here.

3.3.5 Poor sunlighting of outdoor spaces only occurs with certain forms of layout. If a long face of a building faces close to due north then there will be an area adjoining the building which is permanently in shade at the equinox (and hence all winter). Areas slightly further from such a building face will only receive sunlight for a limited time at the beginning or end of the day.

3.3.6 Areas of this sort can also occur if buildings form an enclosed or partly enclosed space which is blocked off from the southern half of the sky. Figure 29 illustrates some typical examples. It is often possible to redesign the layout so as to minimise these areas, either by reorienting buildings or by opening up gaps to the south in courtyards.



Figure 28: This outdoor space is in shade all winter. It is grim and underused.

3.3.7 As a check, it is recommended that at least half of the amenity areas listed above should receive at least two hours of sunlight on 21 March. It is instructive to draw the 'two hours sun contour' which marks this area on plan, because the use of specific parts of a site can be planned with sunlight in mind. This could include reserving the sunniest parts of the site for gardens and sitting out, while using the shadier areas for car parking (in summer, shade is often valued in car parks) (Figure 30). If a detailed calculation cannot be carried out, and the area is a simple shape, it is suggested that the centre of the area should receive at least two hours of sunlight on 21 March (see Appendix G).

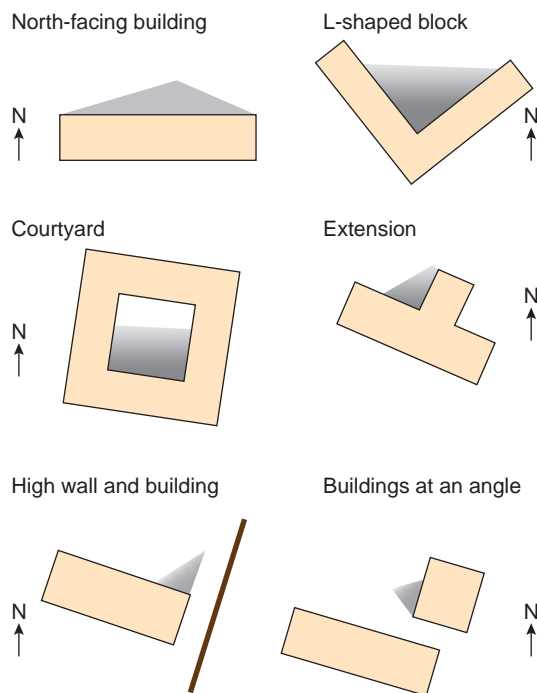

Figure 29: Layouts where poor sunlighting on the ground can occur. The shaded areas will receive no sunlight at the equinox.



Figure 30: Shadier areas can usefully be reserved for car parking

3.3.8 Locations which can and cannot receive two or more hours of sunlight on 21 March may be found using the sun-on-ground indicator (Appendix G*). Sunlight at an altitude of 10° or less does not count, because it is likely to be blocked by low level planting anyway. In working out the total area to be considered, driveways and hard standing for cars should be left out. Around housing, front gardens which are relatively small and visible from public footpaths should be omitted; only the main back garden should be analysed. Each individual garden for each dwelling in a block should be considered separately.

3.3.9 The question of whether trees or fences should be included in the calculation depends upon the type of shade they produce. Normally trees and shrubs need not be included, partly because their shapes are almost impossible to predict, and partly because the dappled shade of a tree is more pleasant than the deep shadow of a building (this applies especially to deciduous trees). Nevertheless choose locations for tree planting with care. The aim should normally be to have some areas of partial shade under trees while leaving other parts of the garden or amenity area in full sun. Where a dense belt or group of evergreens is specifically planned as a windbreak or for privacy purposes, it is better to include their shadow in the calculation of shaded area (Figure 31). The growth of trees and their likely final size should be allowed for. Appendix H gives more details about shade from trees and hedges.

* The sun-on-ground indicators are available as a set of individual transparencies: *Sun-on-ground indicators* (AP 288), available from www.brebookshop.com.



Figure 31: A dense belt of coniferous trees should be treated as an obstruction to sunlight

3.3.10 Fences and walls cast deeper shade than trees and their positions can often be predicted. As a guide, shadows of walls or opaque fences greater than 1.5 m high should be included in the calculation. Where low fences or walls are intended, or railings or trellises which let through sunlight, no calculation of shadows is necessary.

3.3.11 The above guidance applies both to new gardens and amenity areas and to existing ones which are affected by new developments. If an existing garden or outdoor space is already heavily obstructed then any further loss of sunlight should be kept to a minimum. In this poorly sunlit case, if as a result of new development the area which can receive two hours of direct sunlight on 21 March is reduced to less than 0.8 times its former size, this further loss of sunlight is significant. The garden or amenity area will tend to look more heavily overshadowed.

3.3.12 For critical areas, particularly in public open spaces, it is suggested that a more detailed study of sunlighting potential be carried out, using a prediction tool such as one of the sunpath indicators (Figures A5, A6 and A7) in Appendix A, or the BRE sunlight availability protractor, or by shadow plotting.

3.3.13 Where a large building is proposed which may affect a number of gardens or open spaces it is often illustrative to plot a shadow plan showing the location of shadows at different times of day and year. For 21 March this can be done by using the sun-on-ground indicators in reverse (Figures G1 and G3 in Appendix G). For other times of year the sunpath indicators (Figures A5, A6 and A7 in Appendix A) may be used. Alternatively computer software may be used to plot the shadows.

Where there are existing buildings as well as the proposed one, 'before' and 'after' shadow plots showing the difference that the proposed building makes may be helpful. In interpreting the impact of such differences, it must be borne in mind that nearly all structures will create areas of new shadow, and some degree of transient overshadowing of a space is to be expected.

3.3.14 If a space is used all year round, the equinox (21 March) is the best date for which to prepare shadow plots as it gives an average level of shadowing. Lengths of shadows at the autumn equinox (21 September) will be the same as those for 21 March, so a separate set of plots for September is not required. However, clock times of the September shadows will be one hour later, because British Summer Time (BST) will be in force. Shadow plots should state clearly whether the time of the plot is in Greenwich Mean Time (GMT) or BST. BST is currently in force from April to October inclusive.

3.3.15 As an optional addition, plots for summertime (eg 21 June) may be helpful as they will show the reduced shadowing then, although it should be borne in mind that 21 June represents the best case of minimum shadow, and that shadows for the rest of the year will be longer. Conversely if winter shadows (eg 21 December) are plotted, even low buildings will cast long shadows. In a built up area, it is common for large areas of the ground to be in shadow in December.

3.3.16 If a particular space is only used at certain times of day or year (eg a café, outdoor performance area or school playground) it is instructive to plot shadows for those specific times.

Summary

3.3.17 It is recommended that for it to appear adequately sunlit throughout the year, at least half of a garden or amenity area should receive at least two hours of sunlight on 21 March. If as a result of new development an existing garden or amenity area does not meet the above, and the area which can receive two hours of sun on 21 March is less than 0.8 times its former value, then the loss of sunlight is likely to be noticeable. If a detailed calculation cannot be carried out, it is recommended that the centre of the area should receive at least two hours of sunlight on 21 March.

4 SOLAR ENERGY

4.1 INTRODUCTION

4.1.1 As well as bringing warmth and vitality to exterior and interior spaces, the sun is also a source of energy. Good building design should seek to tap this energy to reduce consumption of conventional fuels. Solar energy may cover:

- passive solar, where the form, fabric and systems of a building are designed and arranged to capture and use solar energy
- active solar thermal, using solar collectors with pumps or fans to provide water or space heating
- photovoltaic systems, with solar cells to convert sunlight into electricity.

4.2 PASSIVE SOLAR ENERGY

4.2.1 Passive solar buildings typically include areas of glazing to collect the sun's heat. This glazing may open directly onto occupied areas, or be used to heat sunspaces or other solar collecting features. Passive solar homes generally have a heating energy consumption significantly lower than conventional housing. These benefits depend on the arrangement of the site to produce the best orientation (closest to the south) and to reduce overshadowing. Even houses with no special design features benefit from solar energy if oriented in a north-south direction without overshadowing.

4.2.2 In deciding whether to opt for passive solar design, the needs of the client and the intended use of the building will be important here. Site related factors also influence the decision. On a sloping site which faces north it will be harder to reap the full benefits of passive solar; conversely a south-facing slope will make it easier. At high densities of development (above 40 dwellings per hectare) it becomes difficult to avoid some houses being seriously obstructed or having a poor orientation. Similarly on a small site it may be impossible to achieve the best orientation for window walls or to avoid overshadowing by nearby buildings.

4.2.3 These factors need to be carefully considered in passive solar design if the potential energy savings are to be realised. An alternative approach is to concentrate on providing daylight and sunlight as an amenity (Sections 2 and 3), and perhaps introduce

other energy measures such as improved insulation. The guidance below is intended for those buildings which are specifically designed to make the most of ambient solar energy, when it is intended to supplement the advice in Sections 2 and 3.

4.2.4 Passive solar site layout design can be divided into the two key issues: orientation and overshadowing.

Orientation

4.2.5 To make the most of solar gain the main solar collecting façade should face within 30° of due south. Orientations further east or west than this will receive less solar gain, particularly in winter when it is of most use.

4.2.6 These orientation requirements have considerable influence on site layout. A variety of design solutions is possible, but careful design is needed to offset the monotony that could result from a majority of houses facing south. To achieve a variety of form and spaces, traditional strategies can be used, such as mixing house types, varying the siting within house plots, and good landscaping. Roads will ideally be east-west, but other solutions are possible (Figure 32).



Figure 32: At Willow Park, Chorley, careful road layout design means that all the passive solar homes can have a southerly orientation

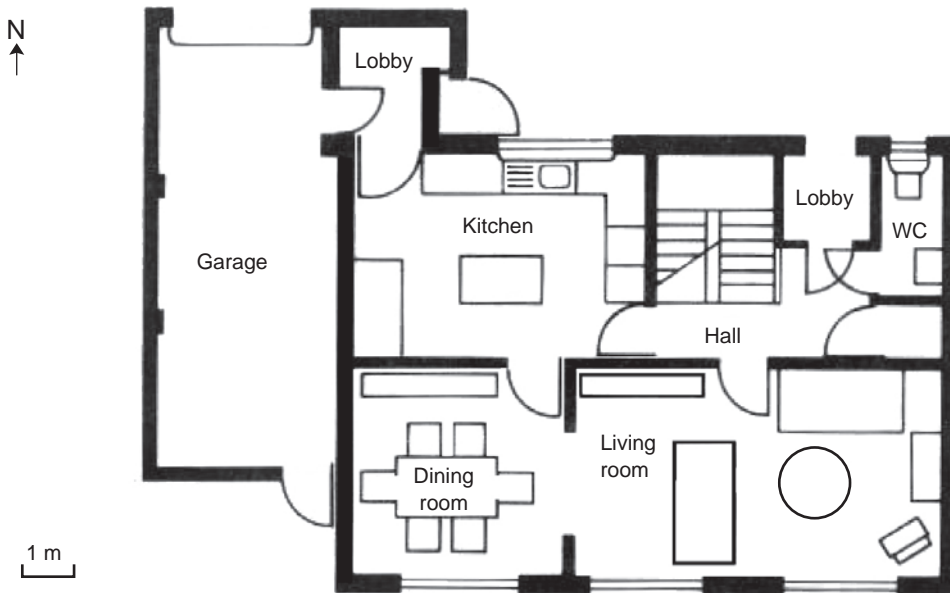

Figure 33: Ground floor plan of Linford low energy house, Milton Keynes

4.2.7 The individual layout of each building will also be affected. In houses, the solar gain will be used most effectively if living rooms are sited on the south side, with kitchens, bathrooms and garages to the north (Figure 33). In non-domestic buildings, toilets, storerooms, computer rooms, canteens and other rooms with high internal heat gains can be located to the north.

Overshadowing

4.2.8 Overshadowing by other buildings can considerably lessen the effectiveness of a passive solar design. A solar collecting façade needs access to low angle sun in winter when its contribution will be most valuable (Figure 34). In the worst case, with large obstructions to the south, a glazed area may be in shadow all winter but receive large amounts of solar heat gain in summer when it is unwanted.

4.2.9 Overshadowing can be minimised by adopting the measures listed in Section 3.1. These include having taller buildings and high density development (such as terraces) to the north of the site, with lower rise, low density development like bungalows and detached houses to the south. Terraces can be placed on east–west roads so that one window wall faces south; where necessary, detached houses can be located on north–south roads. Roof slopes can be reduced to increase solar access to buildings to the north.

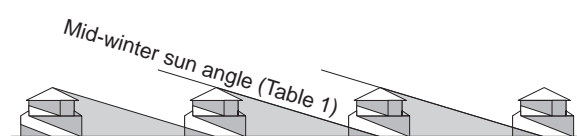

Figure 34: Passive solar homes at Giffard Park, Milton Keynes (top), the terraces at Giffard Park are carefully spaced to avoid winter overshadowing (below)

Table 1: Limiting obstruction angles h to ensure at least three hours of sun in specified period

Period of year	Value of h			
	London	Manchester	Edinburgh	Other location
All year	13°	11°	9°	65° - latitude
21 January to 21 November	17°	15°	12°	68° - latitude
6 February to 6 November	21°	19°	16°	72° - latitude
21 February to 21 October	27°	25°	22°	78° - latitude

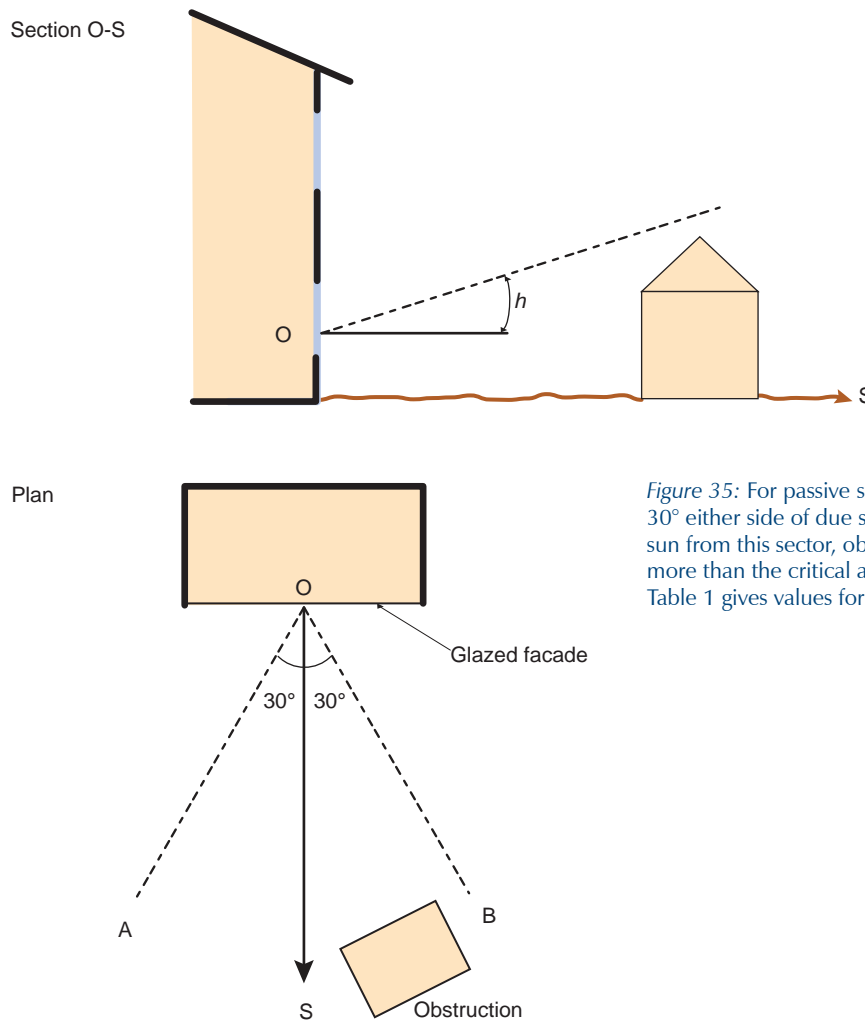

Figure 35: For passive solar gains in winter the sector AOB 30° either side of due south is important. To guarantee winter sun from this sector, obstructions within it should not subtend more than the critical angle h when measured in section. Table 1 gives values for h .

4.2.10 It is also possible to choose plot shapes and the locations of buildings within them to minimise overshadowing. Tree locations are also important; deciduous species are best because they are leafless when solar gains are most valuable, while providing some shade in summer.

4.2.11 To reap the full benefits of passive solar, maximise winter solar gain as far as other site layout constraints allow. For this purpose the most important area to keep lightly obstructed is within $\pm 30^\circ$ of due south of a solar collecting façade (Figure 35). This is the part of the sky from which most solar radiation comes in the winter months. To check whether solar access from this zone is retained, draw a north–south section (not necessarily perpendicular to the façade). The altitude of any obstructions in it should not exceed the critical angle h when measured from the centre of the solar collecting glazing. Values of h are given in Table 1. If this obstruction angle does not exceed h then at least three hours of sunlight around midday are guaranteed for the period specified provided the sun shines of course. Note that the values of h are given in terms of site latitude. So if solar gain was required all year at a site in Cardiff (51.5°N) then the maximum obstruction angle h in Figure 35 would be $65^\circ - 51.5^\circ = 13.5^\circ$.

4.2.12 It is also important to check whether a passive solar building receives enough diffuse daylight (Section 2.1). This may affect the energy efficiency of the building as well as its attractiveness to the occupants. Special care should be taken to ensure good daylighting to the north side of the building as often minimal window areas are chosen on thermal grounds (Figure 36).



Figure 36: In these passive solar homes, a variety of front door positions and a mixture of garages and car ports produce attractive north façades

4.3 ACTIVE SOLAR THERMAL

4.3.1 Overshadowing is normally less of an issue for active solar thermal installations. The collectors are usually roof mounted and hence less likely to be overshadowed. If the system is used for water heating, most of its useful heat will be collected in the summer when solar altitudes are higher, and hence overshadowing is unlikely to happen except at the beginning and end of the day.

4.3.2 An overshadowing/solar gain analysis could still be valuable for some low level collectors, eg in solar systems for heating swimming pools.

4.3.3 Orientation is still an issue. Figure 37 shows the year-round solar radiation reaching an unobstructed collector on a roof pitched at 45° to the horizontal, and facing different directions. Compared to a south orientation, an east- or west-facing collector receives 23% less solar radiation. However, a south-east or south-west orientation is only 6.5% worse than a south-facing one.

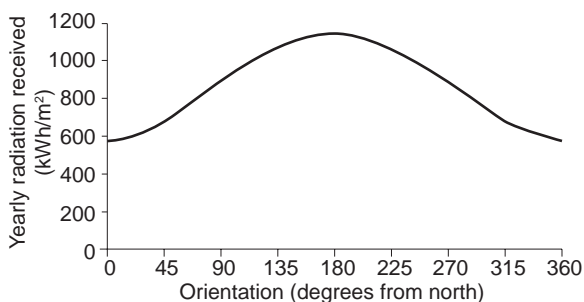

Figure 37: Solar radiation received on a 45° slope, for London

4.4 PHOTOVOLTAICS

4.4.1 Photovoltaic panels, too, are often mounted high on a building. However, they may be used as wall cladding^[6], with some low level photovoltaic cells. Where overshadowing occurs it can have a serious impact on the output of photovoltaic arrays. Even if only one of the cells in an array is shaded, an electrical mismatch can occur and the whole array loses power output.

4.4.2 It is possible to minimise losses by planning the array so that whole strings tend to become shaded at the same times^[9]. Electronic techniques have been developed to use switches to group the modules of an array together according to whether they are shaded or unshaded^[10].

4.5 GENERAL CONSIDERATIONS

4.5.1 Where a proposed development of any type is near to an existing solar building designed to make use of solar gain, it is good practice to try to minimise any loss of that solar gain. However, when designing a solar building the possibility of future development blocking solar access should be anticipated. The building(s) should stand well back from the southern boundary of the site unless it is clear that no future development is to take place there. It is neither reasonable nor prudent to have a solar collector very close to a southern boundary and expect future development to stand well back from it.

4.5.2 When a solar estate is constructed it is wise to guard against the possibility of neighbours blocking each other's solar radiation by erecting large extensions and outbuildings. This can be done by drawing up legal agreements which protect solar access for each property.

5 OTHER ISSUES

5.1 INTRODUCTION

5.1.1 Daylight and sunlight are only two of the issues that need to be considered at the site layout stage. This section briefly mentions some of the other issues which may have an impact on the natural lighting of a layout. Further information can be found listed in the Bibliography.

5.2 VIEW

5.2.1 At the site layout stage in design the needs for view and for daylight rarely conflict; an open, well daylight layout will usually provide reasonable views. There is often a need for specific, close views near to a building, eg for supervision of children playing in a garden, or for security reasons (see below). In this case it may not always be desirable to place windows where they will receive the most daylight or sunlight.

5.2.2 This may constrain the design of passive solar homes. Rooms on the north side of such homes should have enough window area to provide reasonable views out where these are required. This particularly applies to kitchens, which on thermal grounds would normally be sited away from the well glazed south façade.

5.3 PRIVACY

5.3.1 Privacy of houses and gardens is a major issue in domestic site layout. Overlooking, both from public roads and paths, and from other dwellings, needs to be considered. The way in which privacy is achieved will have a major impact on the natural lighting of a layout. One way is by remoteness; by arranging for enough distance between buildings, especially where two sets of windows face each other. Distance helps promote visual privacy but does not guarantee it. An early study^[11] suggests complete visual privacy indoors is only achieved at distances of 90 m or more. Recommended privacy distances are usually less than this but vary widely, typically from 18 m up to 35 m. A spacing-to-height ratio of just over two is normally enough to allow adequate daylighting on building faces; thus for low-rise housing, if these privacy distances are applied, good natural lighting in the layout will ensue automatically. However, smaller scale checks, eg, of overshadowing by extensions, may still be necessary.

5.3.2 The second way of achieving privacy is by design; high walls, projecting wings and outbuildings block direct views of interiors. In this situation natural lighting is often reduced, both because the visual screens themselves block it, and because the spacing between buildings may be much less. To achieve good sunlight and daylight in this type of layout the guidance in Sections 2 and 3 needs to be followed carefully.

5.3.3 Trees, hedges (Appendix H), fences and walls can all provide screening and enhance privacy. However, they also tend to block daylight and sunlight. For visual privacy, screens need to be above standing eye height. Higher screens will block more sunlight and daylight with little extra privacy benefit. Completely opaque barriers give the best privacy but block most light. Porous fences and hedges give a degree of privacy which is enhanced if:

- the holes are neither too large, nor very small and regular^[12]
- people outside cannot go right up to the barrier to peer through
- the barrier is light coloured, superimposing a bright distracting pattern on the view in^[13]
- the barrier has depth, restricting viewing angles into the property.

For shielding of gardens, deciduous hedges and shrubs may be an acceptable compromise. They let through sunlight in winter, but provide effective screening in summer when most outdoor activities take place.

5.3.4 Where external protection cannot provide visual privacy, windows may need to be screened in some way:

- Diffusing glass lets through light but does not allow a view out. A fine diffusing texture is required on the glass otherwise a distorted view may be possible. Frosted glass often has an overall transmittance similar to, or slightly less than clear glass. Fritted glass usually has a lower transmittance.
 - Reflective glass or light coloured net curtains allow a view, but are ineffective at night^[14]. Reflective glass also reduces the amount of daylight entering.
 - Narrow windows with deep reveals restrict viewing into property, although they reduce incoming daylight and sunlight.
-

- A conservatory; although it may be possible to see into the conservatory, it will be less easy to see into the living rooms behind it.
- Adjustable curtains or shutters allow the occupants to control the degree of privacy.

5.4 SECURITY

5.4.1 There may be occasional conflicts between site layout design to provide sunlight and daylight, and security requirements. These may occur in a number of ways.

- To ensure good overall sunlight and daylight in a housing estate it is usually better to space out dwellings evenly, while grouping homes in small clusters promotes neighbourliness and natural surveillance.
- It may be necessary to erect high walls or fences, eg where the rear of a property faces open ground.
- Windows may need to be positioned so that occupants can view areas immediately adjacent to a building. These may not be the best positions for access to sunlight and daylight.
- For maximum sunlight in gardens and planted areas it is best to park cars in shaded areas. However, for security, cars should be easily seen from the occupied building.

5.4.2 These conflicts can usually be resolved by careful site layout design.

5.5 ACCESS

5.5.1 With careful site layout planning it is possible to satisfy the needs for both pedestrian and vehicle access, and adequate sunlight and daylight. The spaces required by roads and footpaths will bring sunlight and daylight into a layout. Tall buildings can be sited to the south of larger road junctions where they will cast shadows on roads rather than on other buildings.

5.5.2 Nevertheless there is often a three-way conflict between good natural lighting, access and privacy (Section 5.3). For maximum privacy large windows should not face roads or other public spaces, even though they would probably receive most sunlight and daylight there. In practice this problem may be overcome by having private zones such as front gardens, or shading devices like net curtains.

5.5.3 Problems with road and footpath layouts may occur in passive solar estates. The best type of road pattern for solar access is a series of long east–west roads with shorter north–south link roads. However, in residential areas shorter, curving roads are usually favoured because this will reduce traffic speed and produce a succession of smaller, more restful looking spaces. Such a road layout will require greater imagination in the design of passive solar housing.

Detached houses or houses with roof collectors may be used on north–south roads, perhaps with gable ends facing the road.

5.6 ENCLOSURE

5.6.1 To achieve good natural lighting within a site, there needs to be enough space between buildings. However, in built up areas the perceived quality of an outdoor space may be reduced if it is too wide and long compared to the height of the buildings that surround it. It may lack human scale and a sense of enclosure.

5.6.2 For higher densities it is still possible to retain a sense of enclosure along with reasonable sunlight and daylight. In linear spaces, such as a street between two rows of terraces, a spacing-to-height ratio of 2.5 would still appear enclosed but not obstruct too much natural light. Conflicts can occur in courtyards. It has been suggested that to appear as an enclosed space a courtyard should have a spacing-to-height ratio of 4 or less. However, courtyards of this shape, completely enclosed on all four sides, will have less than ideal natural lighting. Rooms lit by windows near the corners of the courtyard may appear gloomy and heavily obstructed, and sunlight will only reach half at most of the courtyard in winter.

5.6.3 Such problems can be overcome in a number of ways:

- Including gaps between buildings, especially on the south side of a courtyard, will improve access to sunlight and daylight. If the gaps are not too large the space will still appear reasonably enclosed.
- A larger space between buildings can be ‘broken up’ by vegetation or well defined changes in ground level, into what appears to be a number of smaller spaces.
- Reducing the width of an outdoor space and the height of the enclosing buildings, while keeping the ratio of the two the same, will increase the sense of enclosure while slightly increasing the natural light available at window head level.
- In some circumstances the need for daylight at ground floor level may not be so great, eg where shops occupy the ground floor. Alternatively the ground floor areas could be reduced and they could be lit primarily from the less obstructed side.
- Smaller spacings could be compensated for by increasing window size, especially window head height, and decreasing room depth. This is the approach adopted in Georgian buildings (Figure 3). Appendices C and F give advice on how to achieve this.

5.7 MICROCLIMATE

5.7.1 Access to daylight and sunlight is an important aspect of the microclimate around buildings. The other main element of microclimate is shelter; either from the wind or from excessive solar heat gain in summer.

Choose form and arrangement of building to avoid downdraughts and shelter external spaces

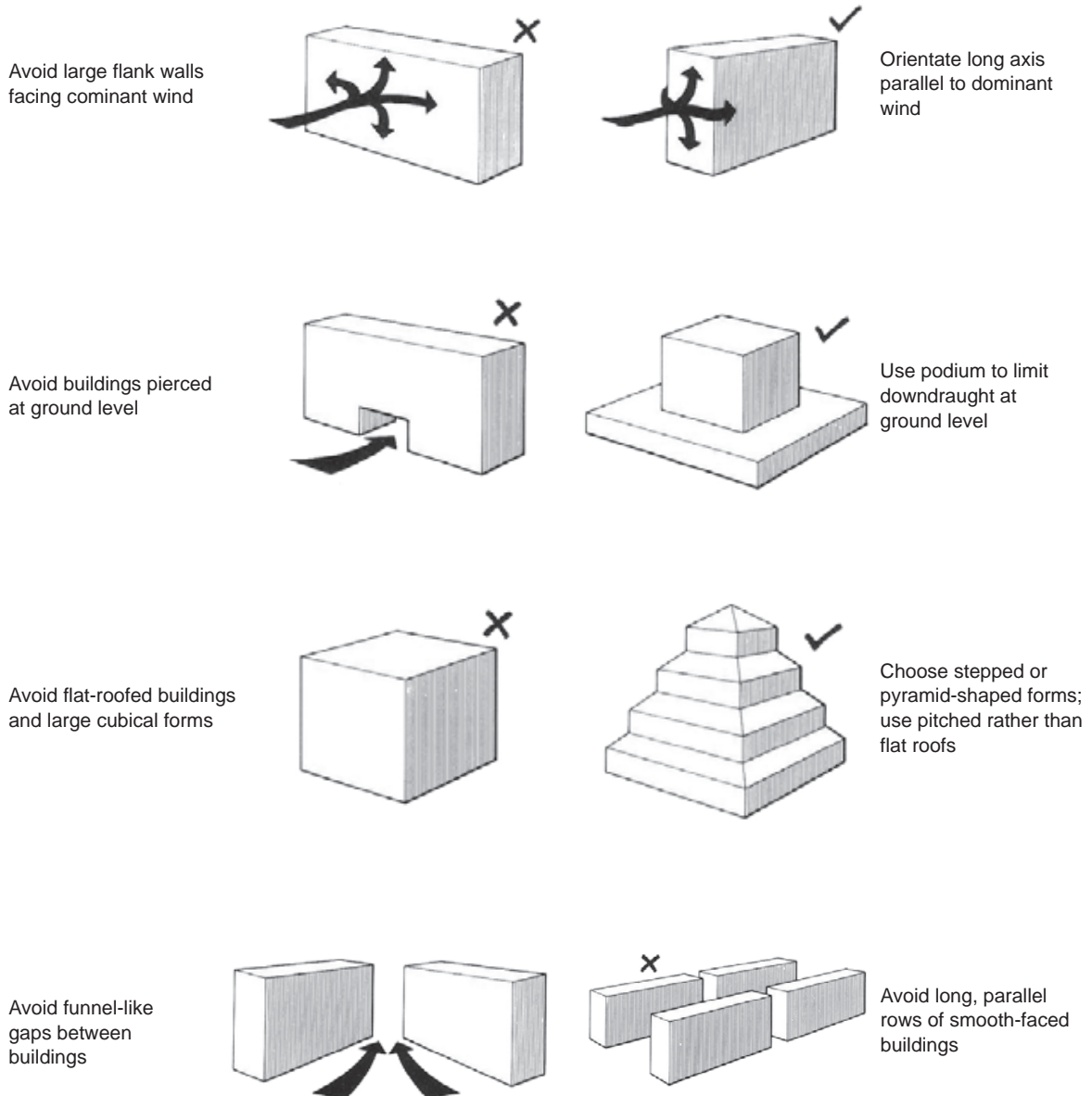

Figure 38: Reducing the wind sensitivity of buildings

There may be a conflict between shelter and solar access requirements. The BRE Report *Environmental site layout planning*^[3] and BRE Digest 350^[14] deal with this issue in detail; only an outline is given here.

5.7.2 Measures to provide shelter from the wind may compromise access to natural light, eg:

- the planting or construction of windbreaks
- the plugging of gaps between buildings through which wind could rush
- the reduction of distances between buildings so that they partly shield each other.

5.7.3 A compromise solution will depend on how exposed the site is. On a particularly exposed site it

may be necessary to plant rows of conifers for use as windbreaks, even if this reduces levels of daylight. Figure 38 shows ways to make individual buildings less sensitive to wind without necessary affecting natural light.

5.7.4 Summertime shade can be provided in a number of ways. Deciduous trees give shade in summer but allow access to sunlight and daylight in winter. Buildings can incorporate shading devices such as overhangs which block high angle summer sun. Making building surfaces a light colour will reduce absorbed radiation and improve reflected light^[15]. Site features like lakes and vegetation can reduce summer temperatures by evaporative cooling and thermal storage.

5.8 SOLAR DAZZLE

5.8.1 Glare or dazzle can occur when sunlight is reflected from a glazed façade (Figure 39) or area of metal cladding. This can affect road users outside and the occupants of adjoining buildings. The problem can occur either when there are large areas of reflective glass or cladding on the façade, or when there are areas of glass or cladding which slope back so that high altitude sunlight can be reflected along the ground (Figures 40 and 41). Thus solar dazzle is only a long-term problem for some heavily glazed (or mirror clad) buildings. Photovoltaic panels tend to cause less dazzle because they are designed to absorb light.

5.8.2 If it is likely that a building may cause solar dazzle the exact scale of the problem should be evaluated. This is done by identifying key locations such as road junctions and windows of nearby buildings, and working out the number of hours of the year that sunlight can be reflected to these points. BRE Information Paper IP 3/87^[16] gives details.

5.8.3 Glare to motorists approaching the building can be an issue. The worst problems occur when drivers are travelling directly towards the building, and sunlight can reflect off surfaces in the driver's direct line of sight (usually this will be off the lower parts of the building).

5.8.4 At the design stage, solar dazzle can be remedied by reducing areas of glazing, reorienting the building, or replacing areas of tilted glass by either vertical or nearly horizontal glazing. Substituting clear or absorbing glass for reflective glass can also help although sometimes even clear glass may cause reflected glare if, eg, a motorist has the reflected sun close to the centre of their line of sight. As an alternative mitigation measure, some form of opaque screening may be acceptable, although this usually needs to be larger than the glazing area.



Figure 39: Solar dazzle reflected from a glazed façade

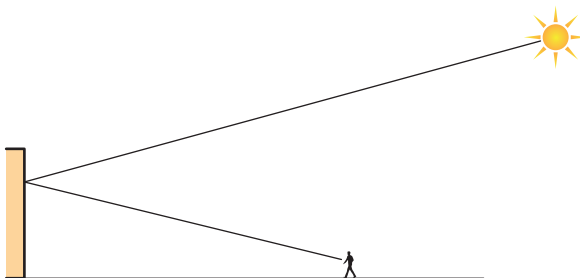

Figure 40: Reflection of low angle sunlight from a vertical façade

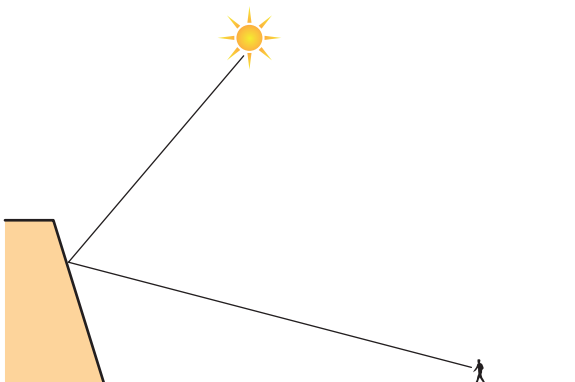

Figure 41: Reflection of high angle sunlight from a sloping façade

REFERENCES

- 1 BSI. Code of practice for daylighting. BS 8206-2:2008. London, BSI, 2008.
 - 2 CIBSE (Chartered Institution of Building Services Engineers). Daylighting and window design. Lighting guide 10. London, CIBSE, 1999.
 - 3 Littlefair P J et al. Environmental site layout planning: solar access, passive cooling and microclimate in urban areas. BRE BR 380. Bracknell, IHS BRE Press, 2000.
 - 4 Energy Saving Trust (EST). Reducing overheating: a designer's guide. CE 129. London, EST, 2005.
 - 5 Royal Institution of Chartered Surveyors (RICS). Rights of light – Practical guidance for chartered surveyors in England and Wales. London, RICS, 2010.
 - 6 Ne'eman E, Craddock J and Hopkinson R. Sunlight requirements in buildings-I. Social Survey Building and Environment, 1976, 11: 217–238.
 - 7 Littlefair P J. Solar shading of buildings. BRE BR 364. Bracknell, IHS BRE Press, 1999.
 - 8 Baker P and Stirling C. Photovoltaics: integration into buildings. BRE DG 438. Bracknell, IHS BRE Press, 1999.
 - 9 Kovach A and Schmid J. Determination of energy output losses due to shading of energy-integrated photovoltaic arrays using a ray tracing technique. Solar Energy, 1996, 57 (2): 117–124.
 - 10 Spratt M, Marshall R and Cross B. A switching strategy to overcome the problem of shading with photovoltaics in buildings. Proceedings North Sun '97, 1997, Helsinki University of Technology, 861–867.
 - 11 Manthore W. Machinery of sprawl. Architectural Review, 1979, 120: 409–422, 1956. Quoted in Finighan WR. Privacy in suburbia: a study of four Melbourne areas. Melbourne, CSIRO.
 - 12 Hill A R and Markus T A. Some factors influencing vision through meshes. Proceedings of the Royal Society A, 1969, 312: 13–29.
 - 13 Treado S J and Bean J W. Optical performance of commercial windows. NISTIR, 1992, 4711, Gaithersburg, Maryland, NIST.
 - 14 BRE. Climate and site development: Part 1: General climate of the UK; Part 2: Influence of microclimate; Part 3: Improving microclimate through design. BRE DG 350. Bracknell, IHS BRE Press, 1983.
 - 15 Smith J. Designing urban streets to minimise heat island effects. BRE IP 19/10. Bracknell, IHS BRE Press, 2010.
 - 16 Littlefair P J. Solar dazzle reflected from sloping glazed façades BRE IP 3/87. Bracknell, IHS BRE Press, 1987.
-

BIBLIOGRAPHY

Daylighting/sunlighting

- BRE. Sun-on-ground indicators. AP 288. Bracknell, IHS BRE Press, 2011.
- BRE. Sunlight availability protractor. BR 12. Bracknell, IHS BRE Press, 1975.
- BSI. Code of practice for daylighting. BS 8206-2. London, BSI, 2008.
- CIBSE (Chartered Institution of Building Services Engineers). Daylighting and window design. Lighting Guide 10. London, CIBSE, 1999.
- Baker N, Fanchiotti A and Steemers K. Daylighting in architecture: A European reference book. London, James and James, 1993.
- Bell J and Burt W. Designing buildings for daylight. BRE BR 288. Bracknell, IHS BRE Press, 1995.
- Crisp V H C, Littlefair P J, Cooper I and McKennan G. Daylight as a passive solar energy option: an assessment of its potential in non-domestic buildings. BRE BR 129. Bracknell, IHS BRE Press, 1988.
- Energy Saving Trust (EST). Daylighting in urban areas. London, EST, 2007.
- Littlefair P J and Aizlewood M E. Calculating access to skylight, sunlight and solar radiation on obstructed urban sites in Europe. BRE BR 379. Bracknell, IHS BRE Press, 2000.
- Loe D and Mansfield K P. Daylighting design in architecture. BRECSU 1997. (Available from the Carbon Trust, London.)
- Neeman E and Light W. Availability of sunshine. BRE CP 75/75. Bracknell, IHS BRE Press, 1975.
- Phillips D. Daylighting: natural light in architecture. Oxford, Architectural Press, 2004.

Rights to light

- Anstey J, Harris L. Anstey's rights of light. London, RICS, 2006.
- Bickford Smith S and Francis A. Rights of light: the modern law. Bristol, Jordans, 2007.
- Ellis P. Rights to light. London, Estates Gazette, 1989.
- Hannaford S, Stephens J and O'Hagan R. Rights to light. Coventry, RICS Books, 2008.
- Redler A. Practical neighbour law handbook. London, RICS, 2006.
- RICS. Rights of light – practical guidance for chartered surveyors in England and Wales. London, RICS, 2010.

Solar design

- Brown G Z and DeKay M. Sun, wind and light: architectural design strategies. New York, Wiley, 2001.
- Chiras D D. The solar house: passive heating and cooling. White River Junction, Canada, Chelsea Green, 2002.
- DTI. Photovoltaics in buildings: Guide to the installation of PV systems. London, DTI, 2006.
- EST. Passive solar estate layout. London, EST, 2000.
- EST. Renewable energy sources for homes in urban environments. London, EST, 2006.
- Halliday S. Sustainable construction. Oxford, Butterworth Heinemann, 2008.
- Knowles R L. Ritual house: drawing on nature's rhythms for architecture and urban design. Washington, Island Press, 2006.

Other issues

- Biddulph M. Introduction to residential layout. Oxford, Architectural Press, 2007.
- Department for Communities and Local Government (DCLG). Housing. Planning Policy Statement 3. London, CLG, 2010.
- DCLG. Better places to live by design: A companion guide to PPG3. London, DCLG, 2001.
- English Partnerships and the Housing Corporation. Urban design compendium. London, 2007. (Downloadable from www.urbandesigncompendium.co.uk.)
- Graves H, Watkins R, Westbury P and Littlefair P J. Cooling buildings in London: overcoming the heat island. BRE BR 431, Bracknell, IHS BRE Press, 2001.
- Gruffydd B. Tree form, size and colour a guide to selection, planting and design. London, Spon, 1994.
- Littlefair P J et al. Environmental site layout planning: solar access, passive cooling and microclimate in urban areas. BRE BR 380. Bracknell, IHS BRE Press, 2000.
- Littlefield D (ed). Metric handbook: planning and design data. Oxford, Architectural Press, 2008.
- Smith J. Designing urban streets to minimise heat island effects. BRE IP 19/10. Bracknell, IHS BRE Press, 2010.

BRE Digests

Climate and site development: Part 1: General climate of the UK; Part 2: Influence of microclimate; Part 3: Improving microclimate through design'. DG 350. Bracknell, IHS BRE Press, 1983.

Photovoltaics: integration into buildings. DG 438, IHS BRE Press, 1999.

Selecting lighting controls. DG 498. Bracknell, IHS BRE Press, 2006.

BRE Information Papers

Littlefair P J. Solar dazzle reflected from sloping glazed façades. IP 3/87. Bracknell, IHS BRE Press, 1987.

Littlefair P J. Average daylight factor: a simple basis for daylight design. IP 15/88. Bracknell, IHS BRE Press, 1988.

Littlefair P J. Innovative daylighting systems. IP 22/89. Bracknell, IHS BRE Press, 1989.

Littlefair P J. Measuring daylight. IP 23/93. Bracknell, IHS BRE Press, 1993.

Littlefair P J and Aizlewood M E. Daylighting in atrium buildings. IP 3/98. Bracknell, IHS BRE Press, 1998.

Littlefair P J. Developments in innovative daylighting. IP 9/00. Bracknell, IHS BRE Press, 2000.

Littlefair P J. Solar energy in urban areas. IP 5/01. Bracknell, IHS BRE Press, 2000.

Smith J. Designing urban streets to minimise heat island effects. IP 19/10. Bracknell, IHS BRE Press, 2010.

APPENDIX A

INDICATORS TO CALCULATE ACCESS TO SKYLIGHT, SUNLIGHT AND SOLAR RADIATION

A1 GENERAL

A1.1 This appendix contains indicators to find how much skylight and sunlight reach the outside of a window. These comprise the:

- skylight indicator (Figure A1), to find the vertical sky component (VSC) (in %) on the outside of a window wall (Section 2).
- sunlight availability indicators (Figures A2 to A4) to find the probable sunlight hours received by a window wall, or at any other point in a building layout (sections 3.1 and 3.2).
- sunpath indicators (Figures A5 to A7) to find the times of day and year for which sunlight is available on a window wall or point in a layout.

A1.2 The sunlight availability and sunpath indicators each come in three different versions according to the latitude of the site in question. The indicators marked 'London 51.5°N' may be used for southern England. The 'Manchester 53.5°N' ones are for northern England and the southern half of Northern Ireland. For Scotland and the northern half of Northern Ireland the 'Edinburgh/Glasgow 56°N' indicators may be used.

A1.3 Indicators for other locations in Europe are given in a separate BRE Report *Calculating access to skylight, sunlight and solar radiation on obstructed urban sites in Europe*^[A1], which also explains how the indicators were constructed.

A1.4 The skylight indicator is independent of latitude and may be used anywhere.

A1.5 The skylight indicator is semi-circular; the sunlight availability and sunpath indicators are shaped like a circle with a segment removed. In each case the centre of the circular arc corresponds to the reference point at which the calculation is carried out. Radial distances from this point correspond to the ratio of the distance of the obstruction on plan divided by its height above the reference point. So if the reference point were 1.5 m above ground, and the ground were flat, this height would be the obstruction height above ground, minus 1.5 m. The indicators are all drawn to the same scale so that it is easy to calculate a number of different quantities at the same time.

A1.6 Directions on the indicator from the central point correspond to directions on the site plan. The skylight indicator is used with its straight base parallel to the window wall. The sunlight availability and sunpath indicators, however, are always used with the south point of the indicator pointing in the south direction on plan, whatever the orientation of the window wall.

A1.7 Unlike the sun-on-ground indicators described in Appendix G, these indicators are not transparent. They are not intended to be laid over standard scale site plans because the distance scale on the indicator is unlikely to correspond to the scale of the plan. To plot a layout on the indicator either the transparent direction finder may be used, or a plan may be specially drawn to the exact scale of the indicator.

Use of the transparent direction finder

A1.8 This is contained in the accompanying pocket on the inside back cover of this guide, and is shown as an illustration in Figure A8. The direction finder is placed on the site plan (of whatever scale). Its centre should be at the reference point and its base parallel to the wall. The direction finder is divided into eight radial zones.

A1.9 To plot an obstruction such as a wall, take each end of the obstruction in turn. Measure its distance in metres from the reference point. Calculate the difference in height between the top of the obstruction and the reference point. Divide the distance away by the height difference to obtain the ratio (distance of obstruction): (height above reference point). Plot a point on the direction finder in the direction of the corner of the obstruction, and at a distance on the radial scale equal to the ratio calculated above. A washable overhead protector pen can be used to make the marks. It is important to realise that the position of the obstruction on the plan will NOT usually coincide with its position on the scale of the direction indicator, although its direction will.

A1.10 Repeat this for the other end of the obstruction and join the two points plotted by a straight line. If the top of the obstruction is level, then the straight line should be parallel to the line of the obstruction on plan. This will not be the case for a sloping obstruction.

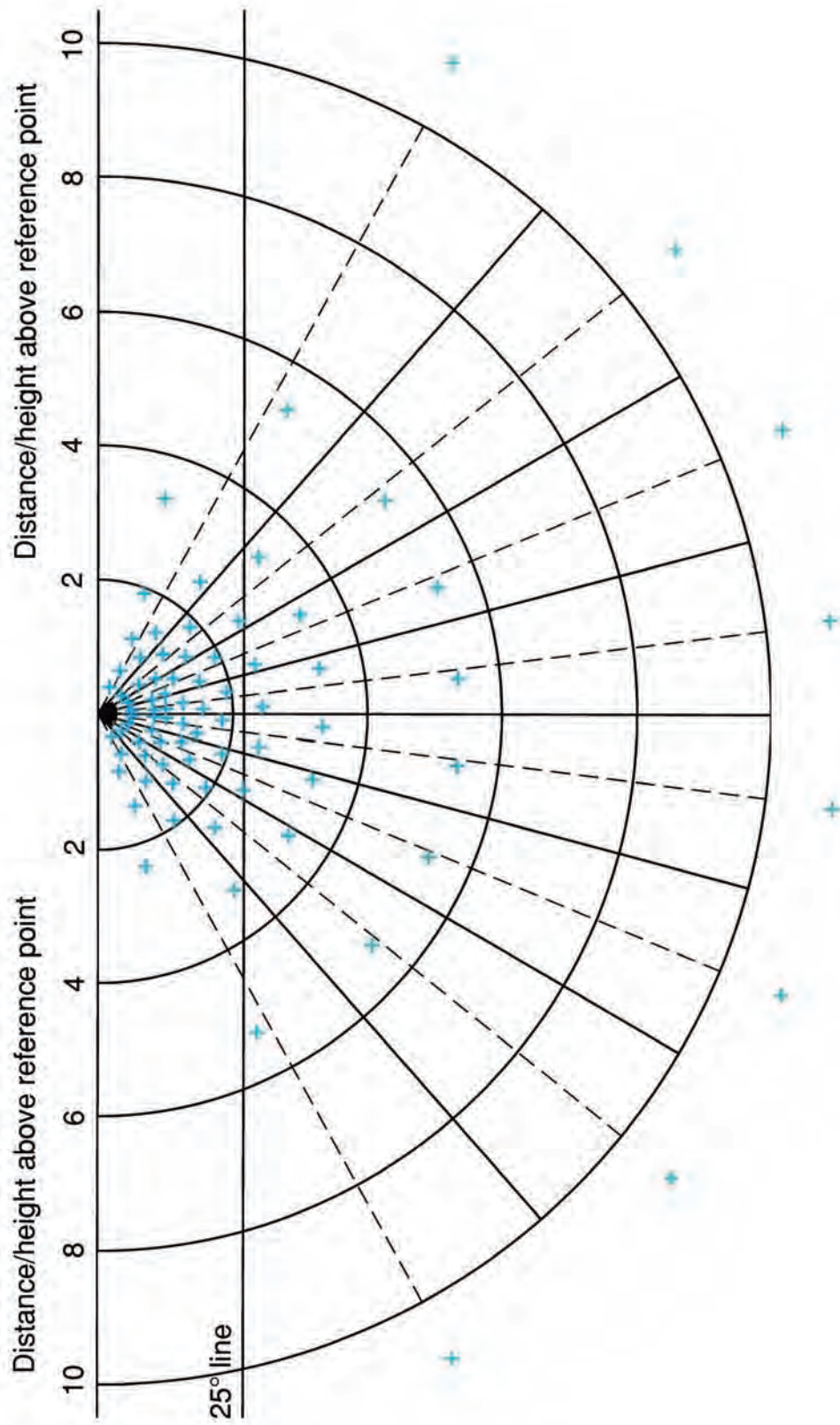

Figure A1: Skylight indicator

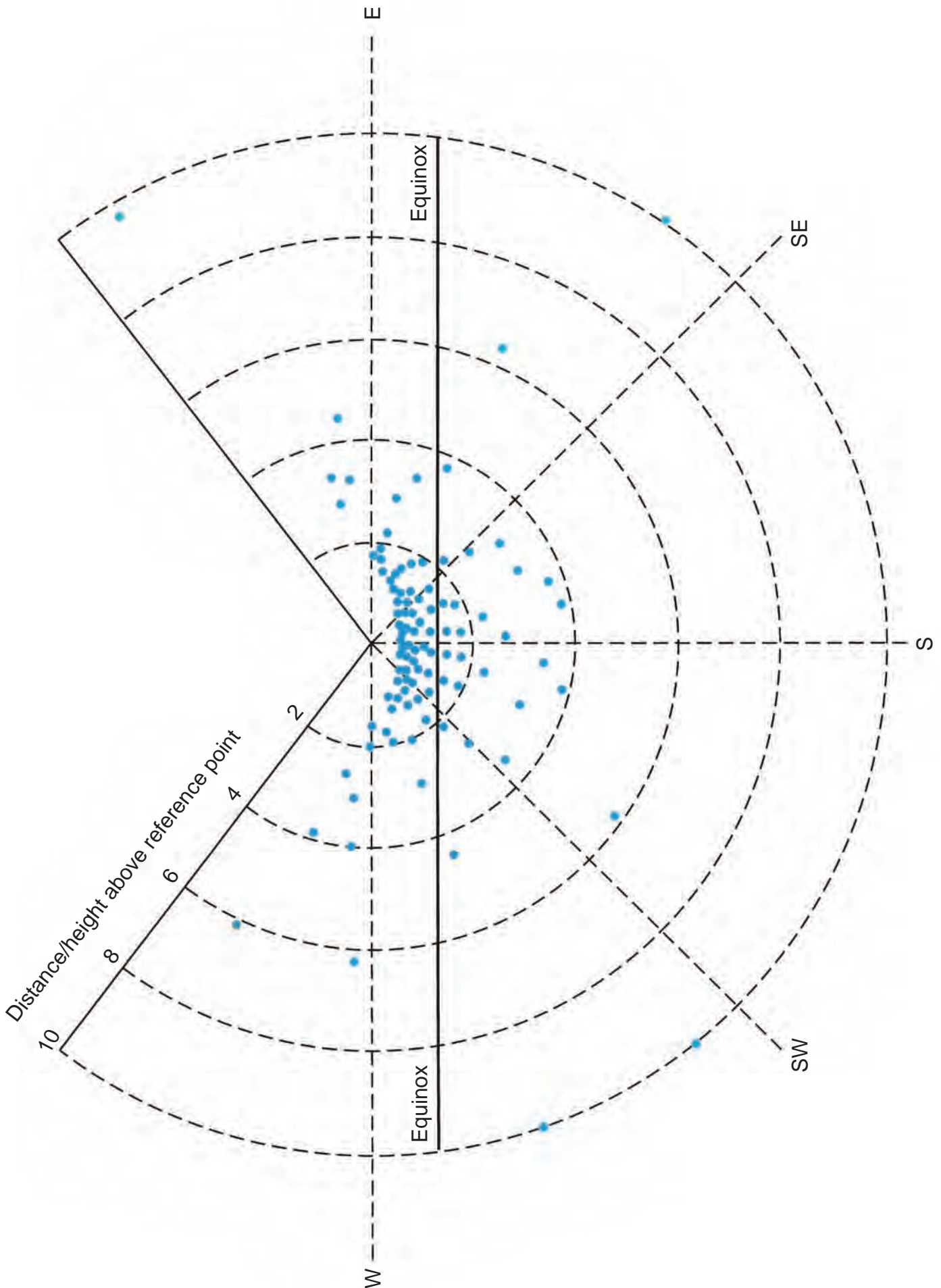

Figure A2: Sunlight availability indicator for London (51.5°N).
The annual unobstructed total is 1486 hours.

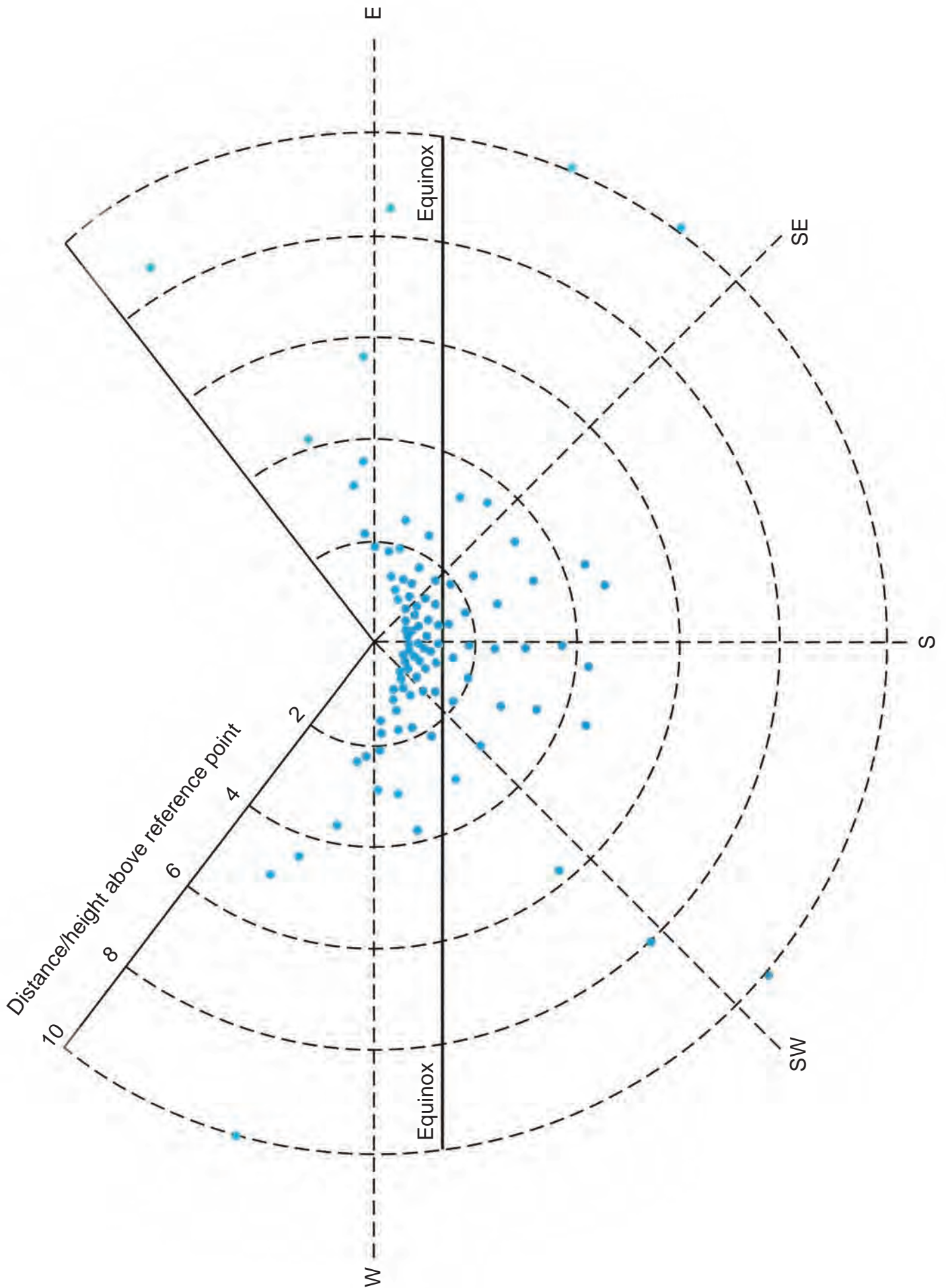

Figure A3: Sunlight availability indicator for Manchester (53.5°N). The annual unobstructed total is 1392 hours.

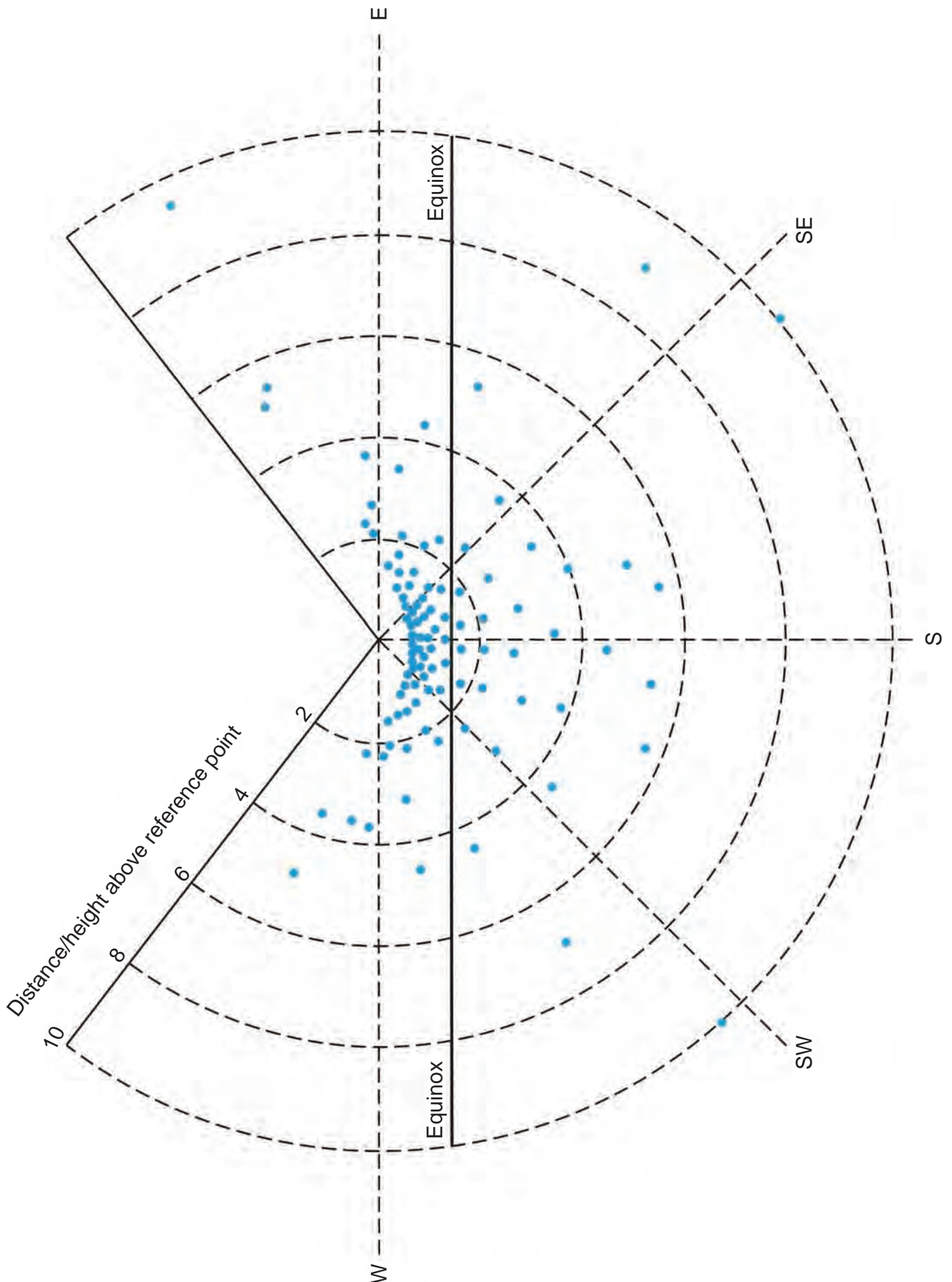

Figure A4: Sunlight availability indicator for Edinburgh/Glasgow (56°N). The annual unobstructed total is 1267 hours.

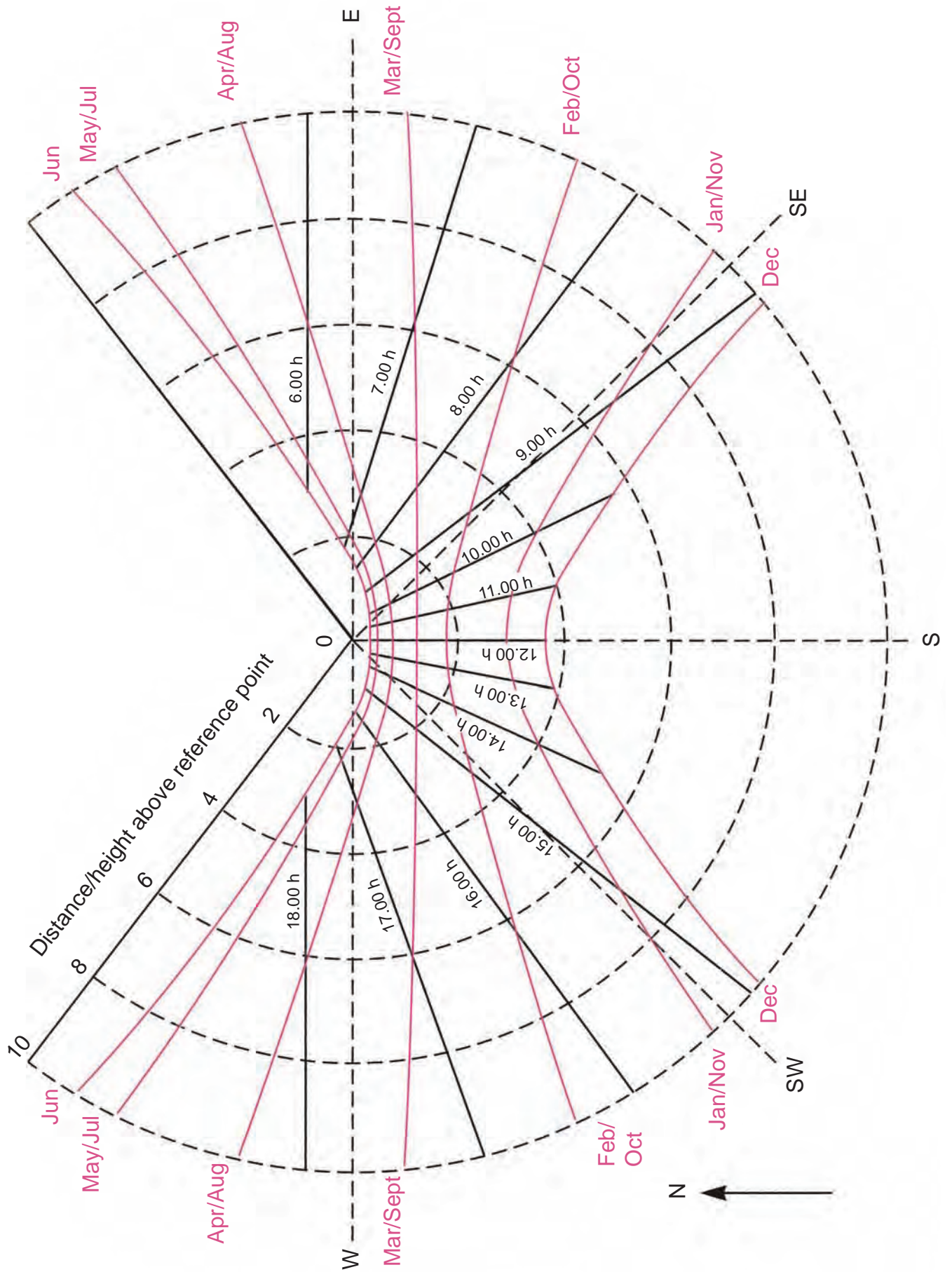

Figure A5: Sunpath indicator for London (51.5°N)

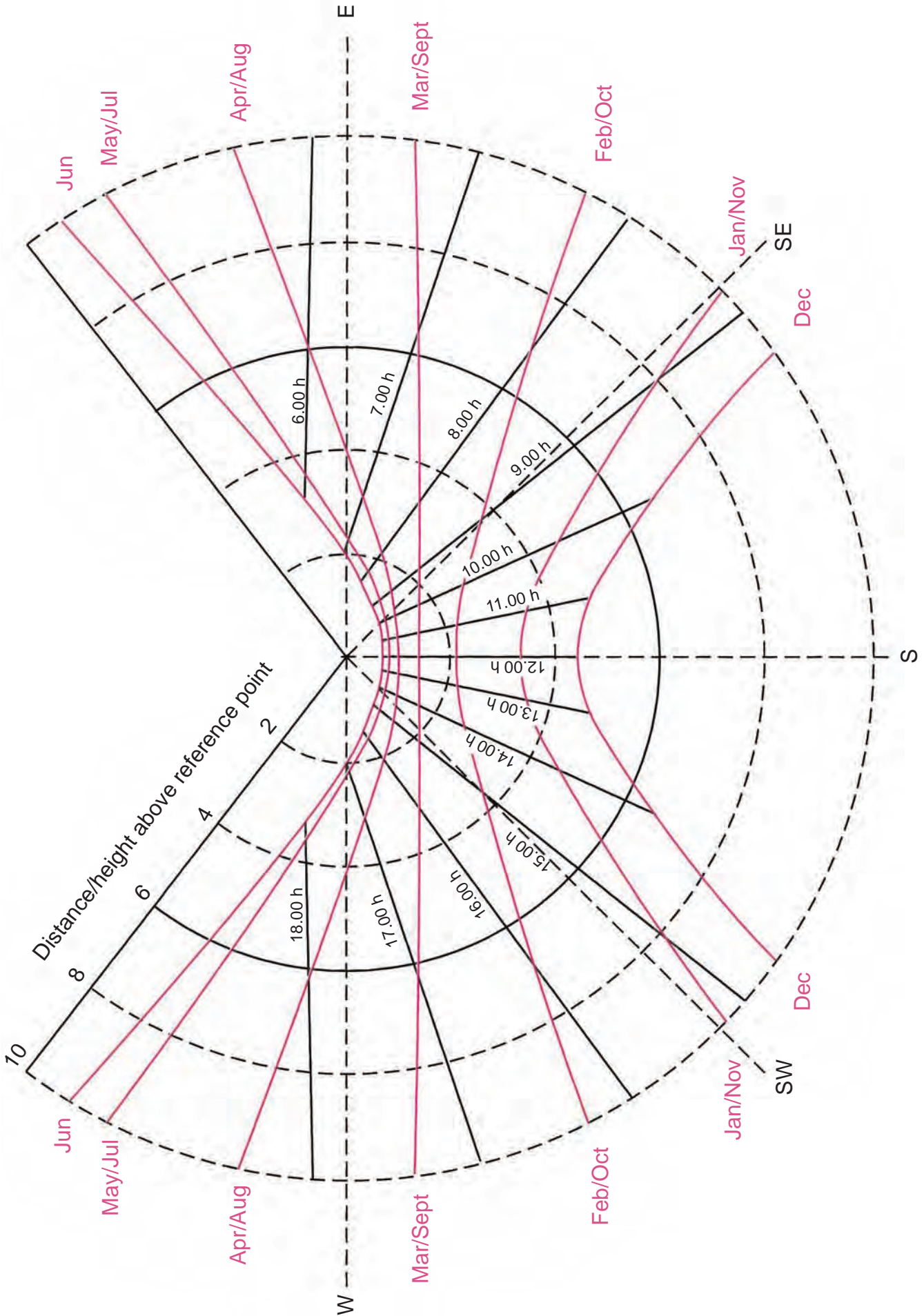

Figure A6: Sunpath indicator for Manchester (53.5°N)

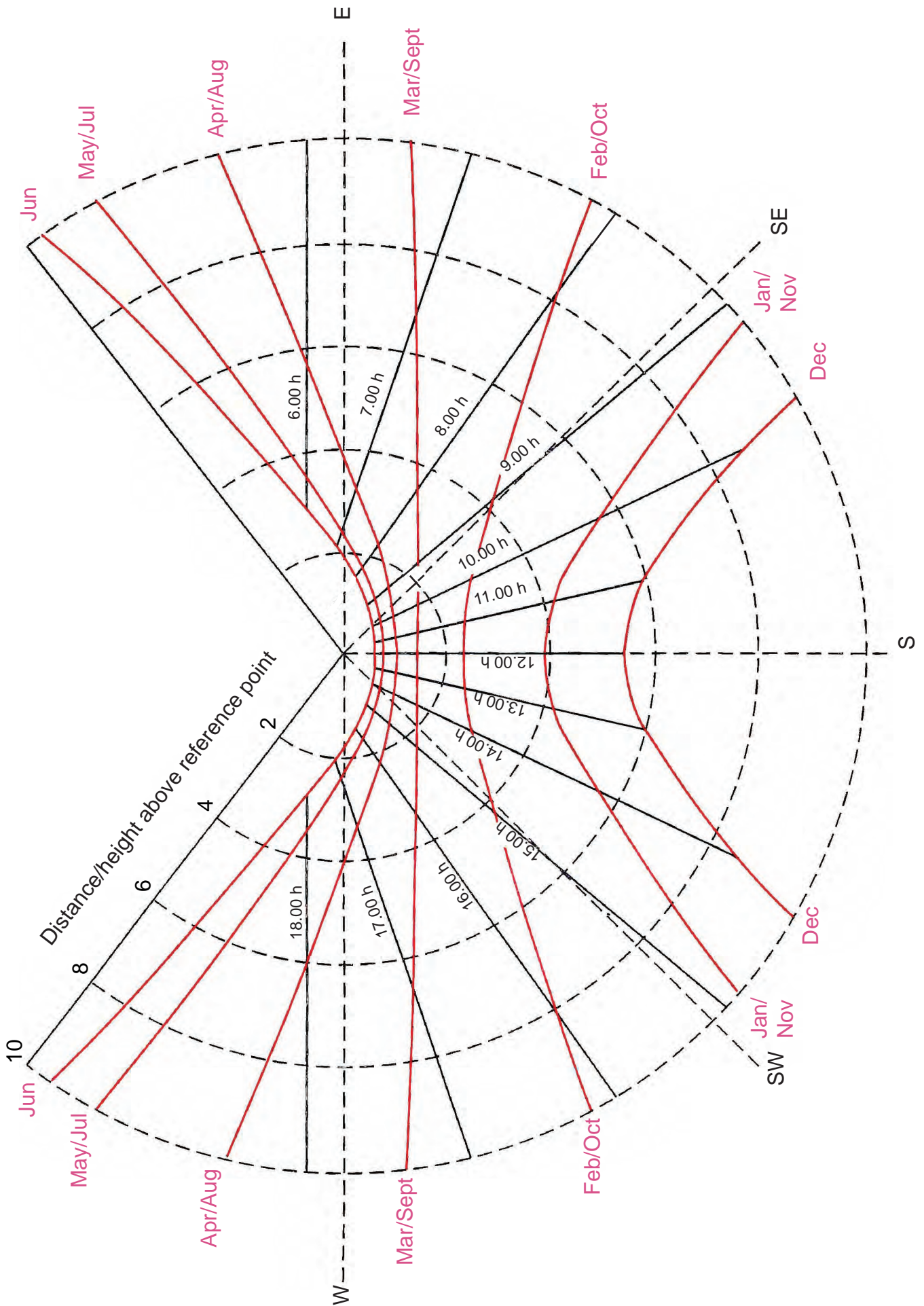

Figure A7: Sunpath indicator for Edinburgh/Glasgow (56°N)

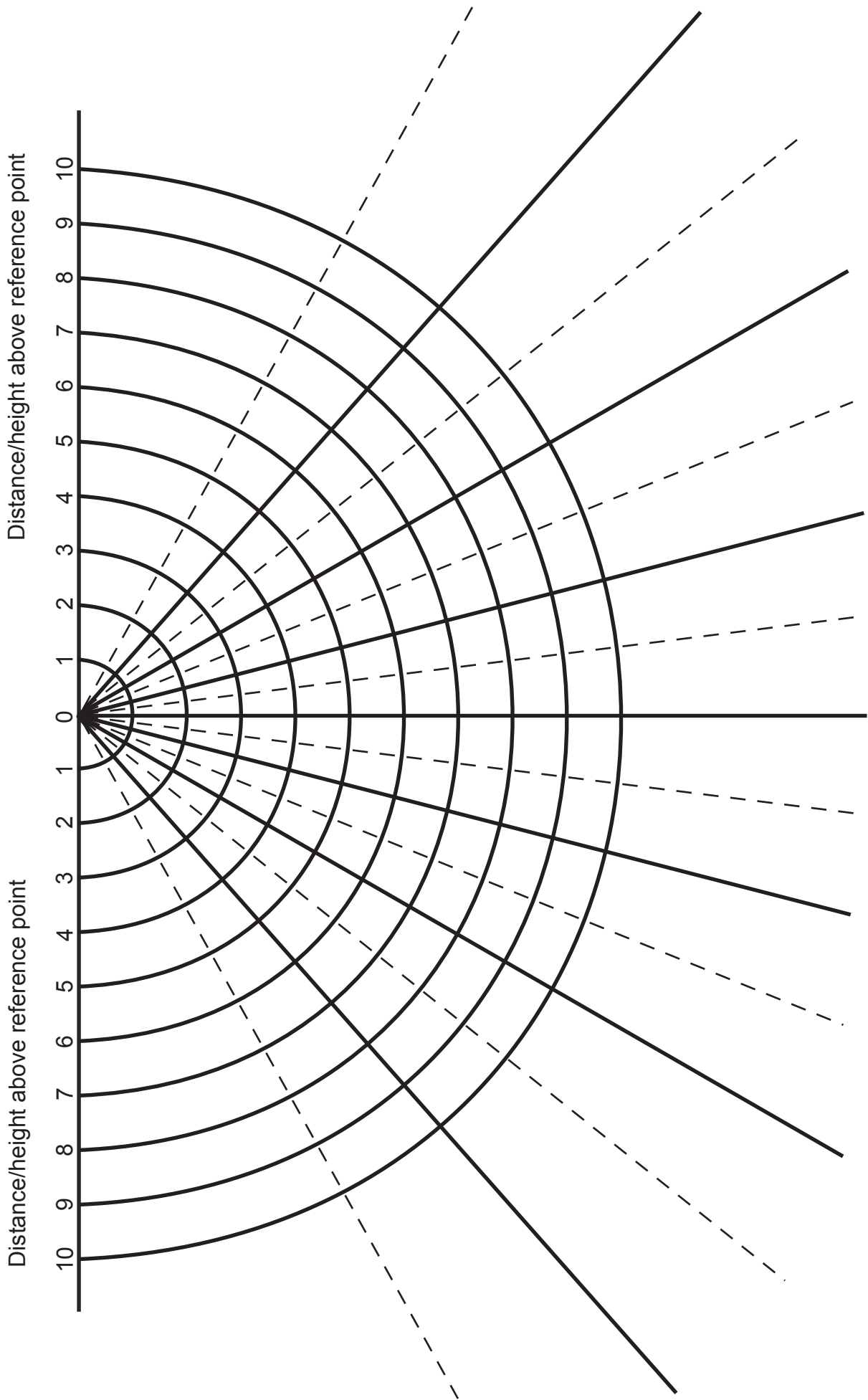

Figure A8: Direction finder for use with the indicators (the transparency is located inside the flap on the inside back cover)

A1.11 For both ends of the obstruction, draw lines from the points plotted to the edge of the direction finder, in the direction away from the centre of the direction finder. Shade the area within the shape created.

A1.12 This process is repeated for every obstruction visible from the reference point. If a house is visible it will usually be necessary to divide it into a series of obstructing elements, eg the eaves, line from eaves to ridge, top ridge, line down to other end of the eaves, and the side of the house if it is visible. Each element is plotted in turn.

A1.13 Figure A9 gives a plan of an example housing layout. It is required to find the daylight and sunlight reaching point O on the plan. The layout is marked on the direction finder as shown in Figure A10. The base of the direction finder is laid parallel to face POQ. Each obstruction is then considered in turn.

A1.14 A proposed extension QRS is plotted as follows. Only the line QR needs be plotted as this is the only face of the extension that can be seen from point O. Point Q is 5 m from O, and 5 m above it. This is a distance to height ratio of 1. This end of the extension is therefore plotted at point Q' on the direction finder, at a distance of 1 unit from the centre, along the line (in this case the wall of the building) towards Q. The other end of the extension, point R, is 10 m on plan from O and 5 m above it. So R' is marked where the radial line OR intersects the distance: height arc of 2 (10 divided by 5). Points Q' and R' are then joined together. Note that the horizontal

extension plotted on the direction finder is parallel to the line of the extension on the original plan.

A1.15 A line is then drawn from the end of the plotted extension R' to the edge of the direction finder, along the radial line from the centre of the direction finder. The area to the right of this line is shaded; these shaded areas represent areas of the sky that the extension will block. In this case the new development has been plotted in a different colour (red) to the existing buildings (green). This is to facilitate the calculation of daylight and sunlight with and without the new development.

A1.16 EFGH is a house with a pitched roof. In this case, both the eaves and the ridge are plotted. Point E is 21.5 m from O and 5 m above it. So the distance/height ratio is 21.5 divided by 5 = 4.3. Point E' on the direction finder is therefore plotted 4.3 units from the centre, along the radial line towards point E. Point F' is plotted in a similar way, and the two are joined together to give the line of the eaves as an obstruction on the direction finder.

A1.17 However, in this case the ridge also forms an effective obstruction, because the house is far enough away so that its roof can be seen from point O. Line I'J' is the line of the ridge plotted on the direction finder. It forms an additional obstruction. The lines E'I' and F'J' are also drawn; these correspond to the sloping edges of the roof. All the area behind the lines E'I', I'J', and J'F' is shaded; this represents the sky blocked by the house.

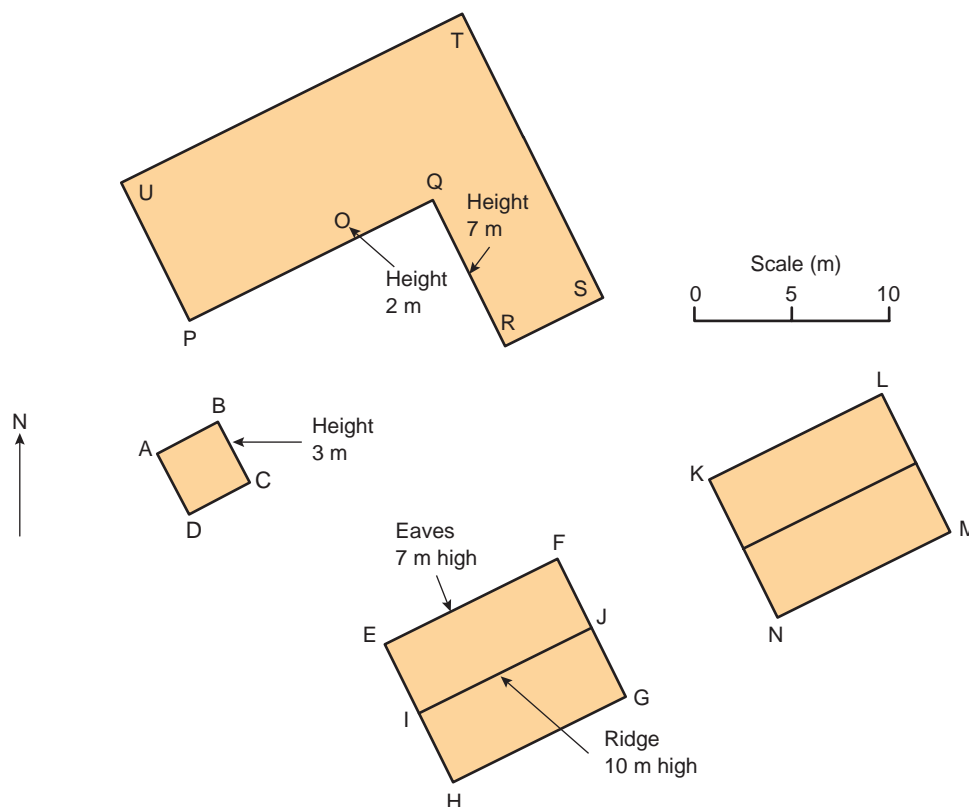

Figure A9: Site plan of an example situation: housing layout

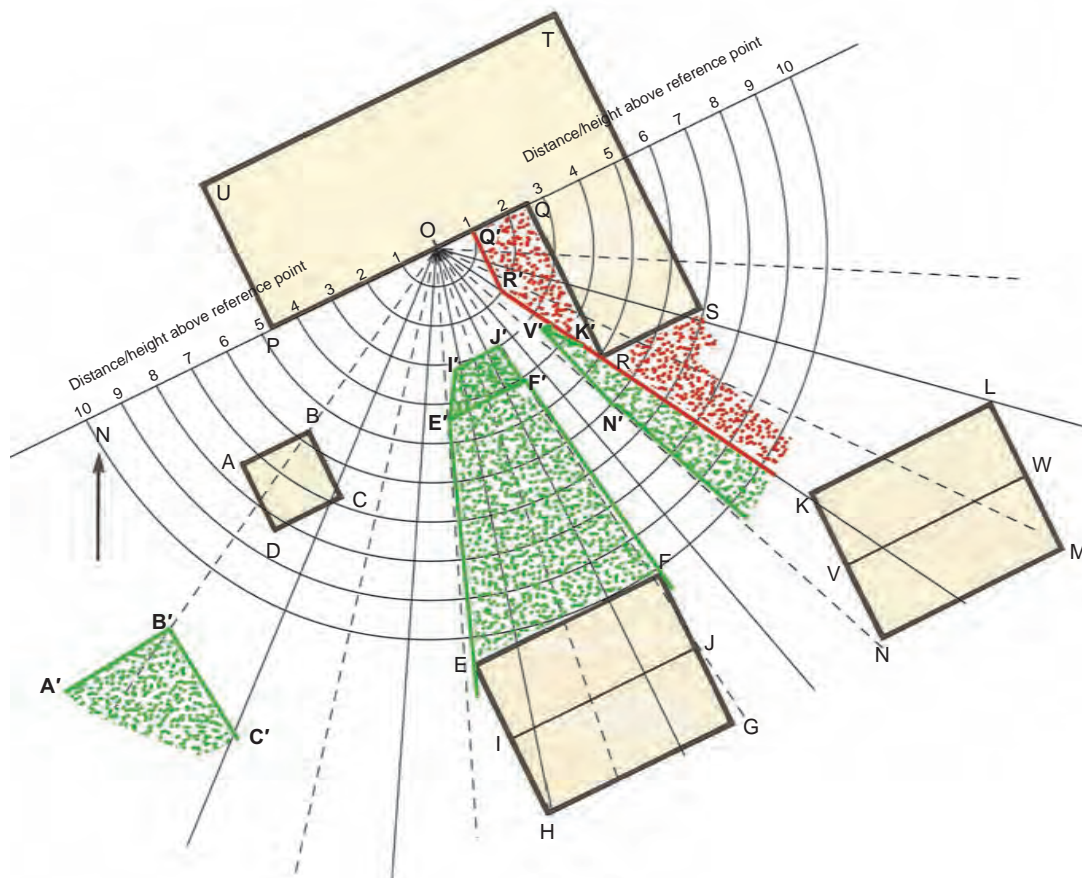

Figure A10: Housing example situation shown in Figure A9 plotted onto the direction finder

A1.18 House KLMN is plotted in a similar way, except that the side of the house KN has to be plotted, because it will be visible from O.

A1.19 The nearest point on shed ABCD, point B, is 12 m from O and it is 1 m above point O. So its distance to height ratio is 12. This is actually off the scale of the direction finder, thus this shed is unlikely to be a significant obstruction to daylight. In general, obstructions whose distance is more than 10 times their relative height can be ignored.

A1.20 The resulting plot of the obstructions can then be used with the indicators as described below. For use with the sunpath and sunlight availability indicators, the south point of the layout should be marked on the direction finder.

Table A1: Scales of plan for use directly with indicators

Height of obstruction above reference point (m)	Scale of plan
1	1:100
2	1:200
3	1:300
4	1:400
5	1:500
6	1:600
7	1:700
8	1:800
9	1:900
10	1:1000
15	1:1500
20	1:2000

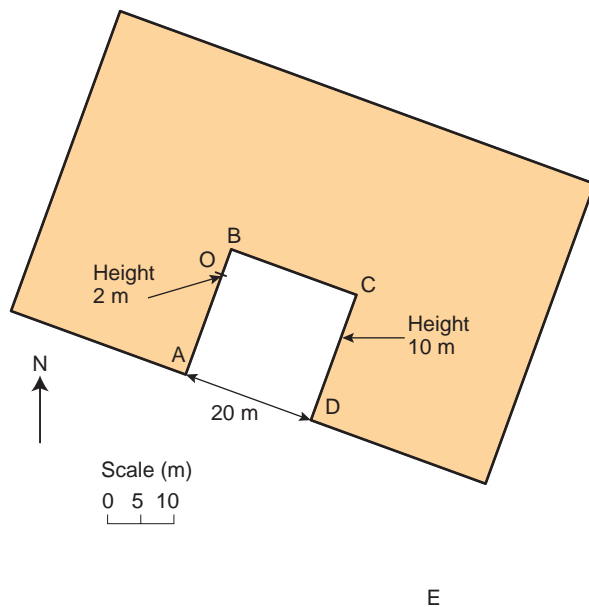

Figure A11: Site plan of an example situation; courtyard layout

Use of a plan drawn to a specific scale

A1.21 If there is only one obstruction, or if all the obstructions are the same height above the reference point, it is usually easier not to use the direction finder but to draw a special plan. The plan is drawn on tracing paper, or photocopied onto acetate, so that it can be laid over the indicators.

A1.22 It is essential to draw the plan to the correct scale. The scale to be used will depend on the height of the obstruction above the reference point for the calculation. If this distance is h m then the plan should be drawn to a scale of $1:100h$. Table A1 gives scales for some obstruction heights.

A1.23 Figure A11 illustrates a site plan of an example situation for a courtyard layout. It is a plan of an office block 10 m high. The office block has a central, three sided courtyard. The daylight and sunlight reaching point O, 2 m above ground on the west side of the courtyard need to be found.

A1.24 The top of the courtyard is 8 m above point O. So the plan of the building needs to be redrawn to a scale $1:800$ (Figure A12). The width of the courtyard (20 m) will be 25 mm in this scale.

A1.25 If the daylight and sunlight are required on a vertical façade (in this case BOA), the line of the façade should be drawn in (it does not matter if it is a different height to the obstructions). For sunlight calculations a south point should also be included. Finally, mark out those areas of the plan from which point O is prevented from receiving light. This is done by drawing radial lines outwards from O from each end of the obstruction. In this case there is just one such line, line DE. Areas to the right of line DE cannot be seen from O. Then the plan can be laid over the indicators as follows.

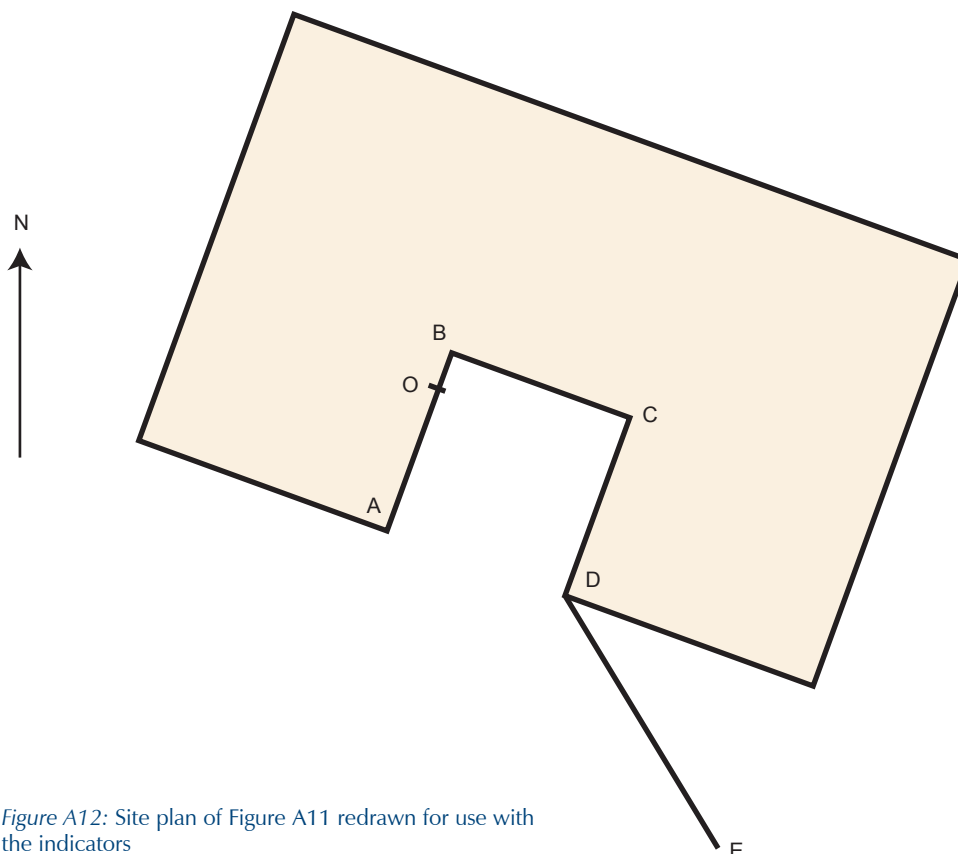

Figure A12: Site plan of Figure A11 redrawn for use with the indicators

A2 USE OF THE SKYLIGHT INDICATOR

A2.1 To use the skylight indicator (Figure A1), take the marked direction finder or specially prepared plan and lay it over the indicator. The centre of the indicator should correspond to the reference point, with its base parallel to the line of the vertical plane.

A2.2 The skylight indicator has 80 crosses marked on it. Each of these corresponds to 0.5% VSC. If a cross lies nearer to the centre of the indicator than any obstruction in that direction (as marked on the direction finder or special site plan) then it is unobstructed and counts towards the total VSC. If it lies beyond the obstruction then it will be obstructed and does not count. The VSC at the reference point (in %) is found by counting up the number of unobstructed crosses and dividing by two. If a

cross lies on the edge of a plotted obstruction, half a cross (0.25%) can be counted.

A2.3 Figure A13 shows how VSC is found in the housing layout example (Figure A9). The marked direction finder (Figure A10) is laid over the skylight indicator. For clarity, some of the numbers and semi-circles on the direction finder have been omitted. The shaded areas lie beyond the obstructions and therefore crosses in these areas do not count. That leaves 62 crosses in the unshaded areas which will contribute to the skylight at point O; a VSC of just over 31%.

A2.4 In Figure A14 the courtyard layout (Figure A11) is analysed. The specially drawn site plan (Figure A12), on tracing paper, is laid over the skylight indicator. Here

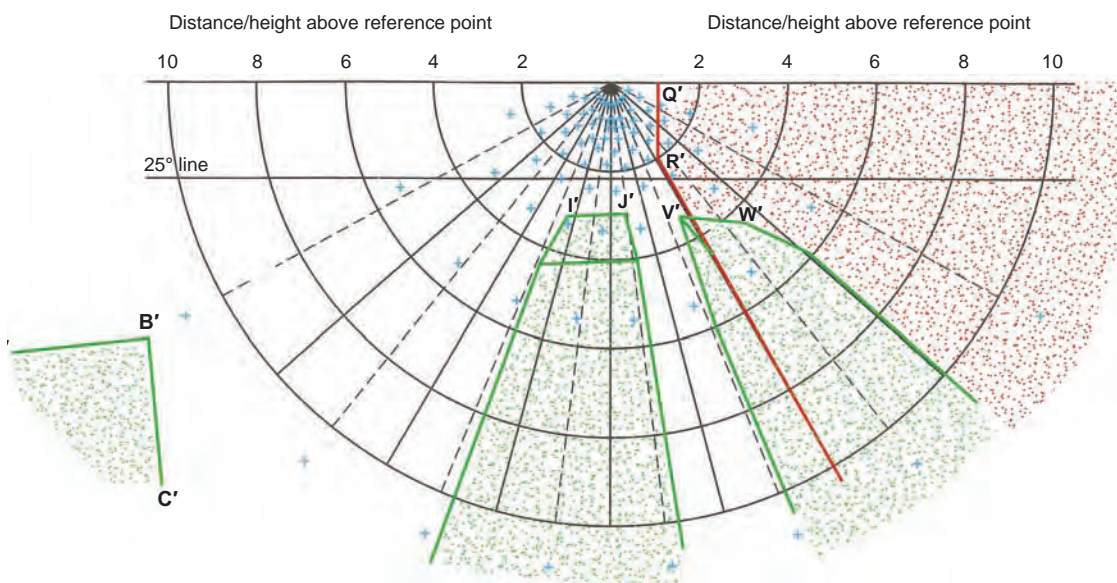

Figure A13: Direction finder plot of housing layout (Figures A9 and A10) laid over skylight indicator

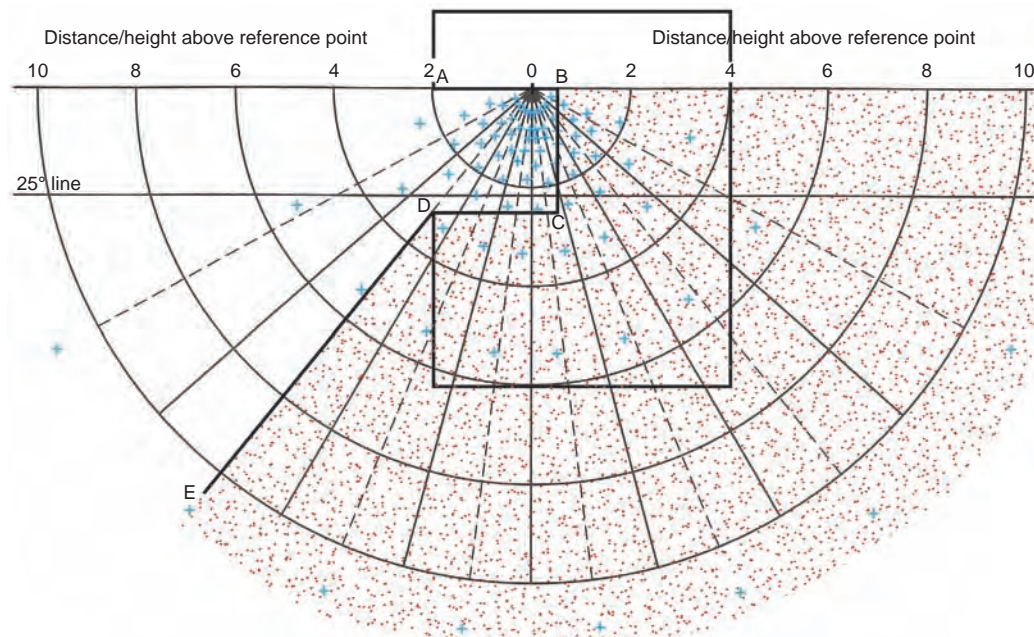

Figure A14: Special site plan (Figure A12) of courtyard layout laid over skylight indicator

the number of unobstructed crosses is 47, so the VSC is 23.5%. Note that crosses in the shaded area to the right of line DE do not count as these areas of sky would be blocked by face DC.

A2.5 Counting up the crosses can be speeded up in various ways:

- If a point is lightly obstructed then count up the obstructed crosses, divide by two and subtract this from 40% (the value for an unobstructed vertical plane) to give the VSC. In the housing layout example, existing obstructions (plotted in green on Figure A13), block eight crosses. The VSC for the existing situation would be $40\% - 8/2 = 40\% - 4\% = 36\%$.
- Each of the eight radial zones contains 10 crosses. So if a zone is completely unobstructed it will contribute 5% to the VSC.
- To check whether the VSC exceeds 27% (the value for a long straight obstruction subtending 25° on section), the 25° line can be used. If the number of obstructed crosses above the 25° line (between it and the reference point) is less than the number of unobstructed crosses below this line then the 27% value is exceeded. In Figure A14 there are 13 obstructed crosses above the 25° line, and only six unobstructed crosses below it. So the courtyard layout has a VSC of less than 27%.

A3 USE OF THE SUNLIGHT AVAILABILITY INDICATORS

A3.1 To estimate sunlight availability, first choose the indicator (Figures A2 to A4) which corresponds best to the latitude of the site (see Section A1). Indicators for latitudes further north or south are given in a separate BRE Report *Calculating access to skylight, sunlight and solar radiation on obstructed urban sites in Europe*^[A1]. Take the marked direction finder or specially prepared plan and lay it over the indicator, with its centre at the reference point. However, this time the south point on the indicator should be parallel to the south point marked on the direction finder or site plan, regardless of which way the building faces. This is an important difference from the skylight indicator.

A3.2 The sunlight availability indicator has 100 spots on it. Each of these represents 1% of annual probable sunlight hours (APSH). The effects of obstructions are found in the same way as for the skylight indicator. If a spot lies nearer to the centre of the indicator than any obstruction in that direction (as marked on the direction finder or special site plan) then it is unobstructed. The percentage of APSH at the reference point is found by counting up all the unobstructed spots. The numerical total of annual sunlight hours is found by multiplying this fraction by the annual total hours for an unobstructed plane, given in the caption to the indicator (Figures A2, A3 and A4).

A3.3 BS 8206-2 *Code of practice for daylighting*^[A2] recommends that at least 25% of APSH be available at the reference point, including at least 5% of APSH in the six months between 21 September and 21 March (in winter). To check this, use the horizontal equinox line on the indicator. At least 25 spots should be unobstructed, with five or more of them below the equinox line. If the calculation point is on a wall of a building, then sunlight from behind the building cannot of course reach it. So any spots on the building side of the wall on which the reference point lies will be obstructed.

A3.4 Figure A15 shows this indicator being used for the housing layout in Figure A9. The marked direction finder (Figure A10) is laid over the indicator (in this example, for Edinburgh/Glasgow 56°N shown in Figure A4). Its south direction, taken originally from the site plan, is parallel to the south point on the indicator. For clarity, the markings and semi-circles on the direction finder are not shown. The shaded areas would be blocked by the obstructions. Note that areas above the direction finder base are also shaded because sunlight from these directions would be blocked by the building on which point O lies.

A3.5 From Figure A15, the total percentage of APSH reaching point O is 64%, of which 24% are in the six winter months. Thus point O easily meets the BS 8206-2 recommendation. The total probable sunlight hours reaching O is 64% of 1267, or 811 hours per year.

A3.6 In Figure A16 the courtyard layout (Figure A11) is assessed. The specially drawn site plan (Figure A12) is laid over the indicator, with the two south directions, on plan and indicator, parallel. Note that wall BOA has been continued to A' because sunlight from areas to the north west of AA' will not be able to reach point O. Similarly sunlight from north east of line DE will be prevented by wall CD from reaching point O. The total sunlight availability at O is 46% of annual probable hours, 16% of these being in the winter months. Thus the BS 8206-2 recommendation is satisfied here too.

A4 USE OF THE SUNPATH INDICATORS

A4.1 The sunpath indicators (Figures A5 to A7) give the times of day and year at which sunlight can reach a reference point. The bold curved lines which run across the indicator are sunpaths for the 21st of each month (the months are labelled around the perimeter). Each sunpath is divided into hours by the thinner straight solid hour lines which radiate outwards. These are labelled with solar time which is almost the same as GMT (add one hour for BST). Where the time of day is unusually important, solar time can be corrected using the method described in the BRE Report *Availability of daylight*^[A3].

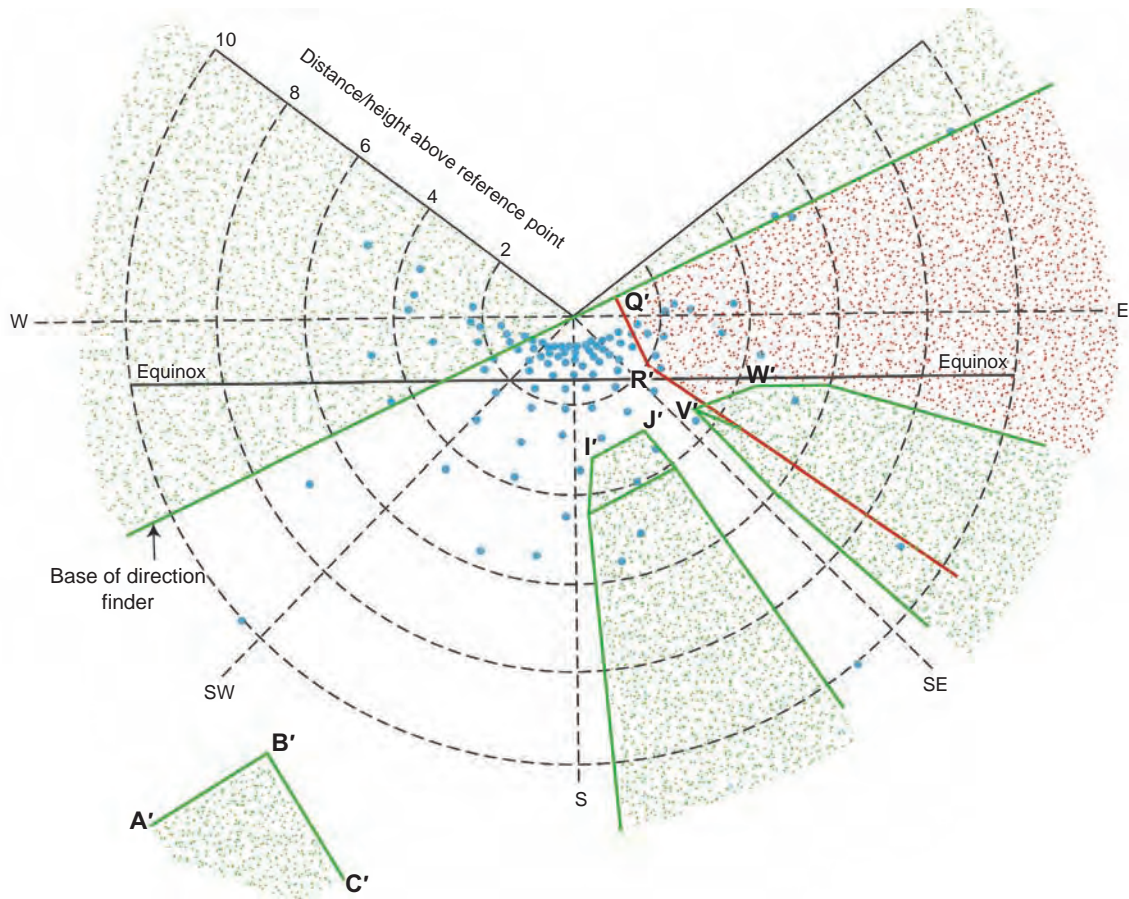

Figure A15: Direction finder plot of housing layout (Figures A9 and A10) laid over sunlight availability indicator

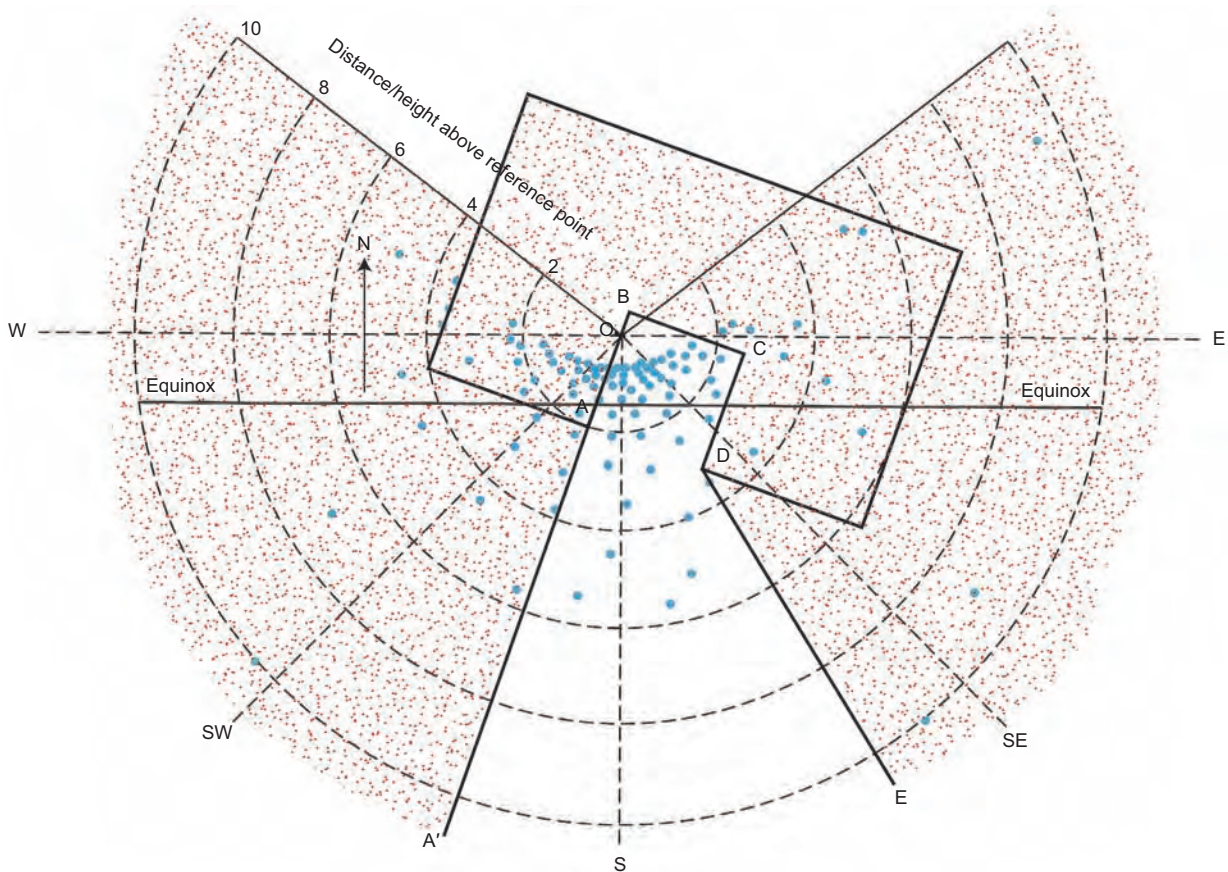

Figure A16: Special site plan (Figure A12) of courtyard layout laid over sunlight availability indicator

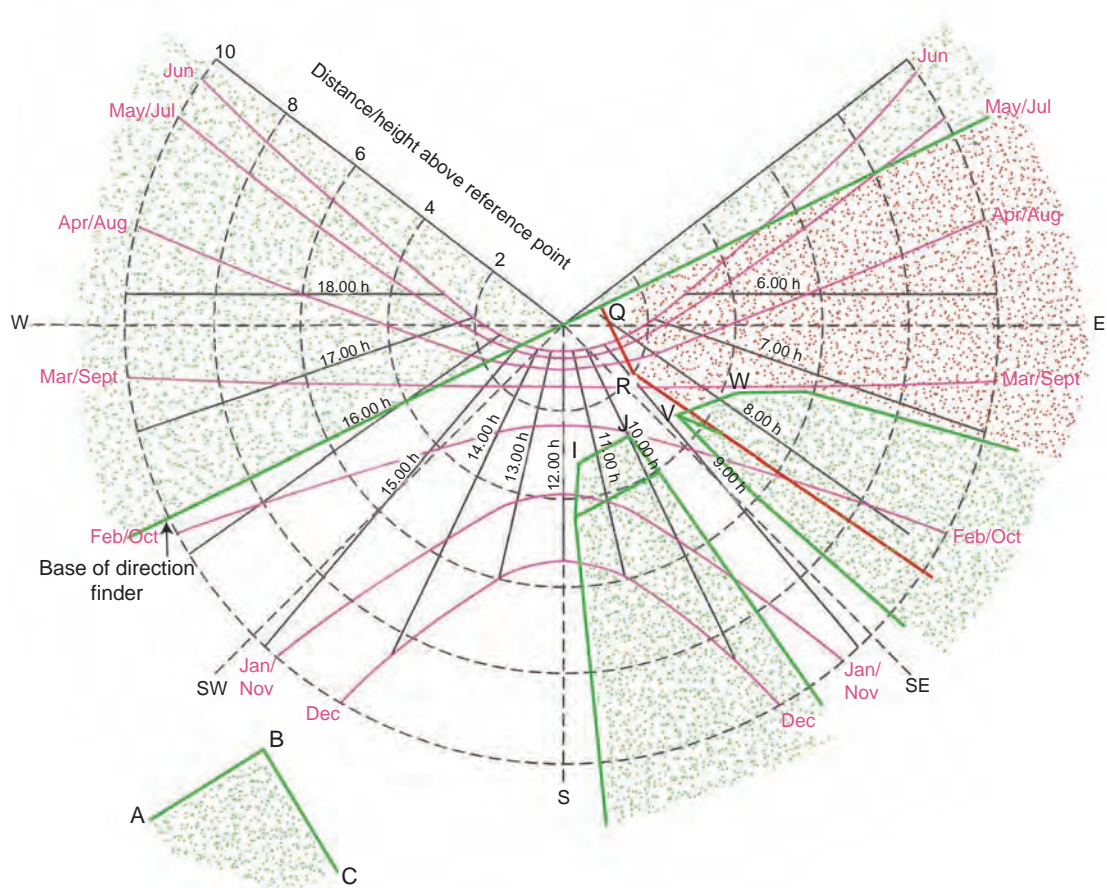

Figure A17: Direction finder plot of housing layout (Figures A9 and A10) laid over sunpath indicator

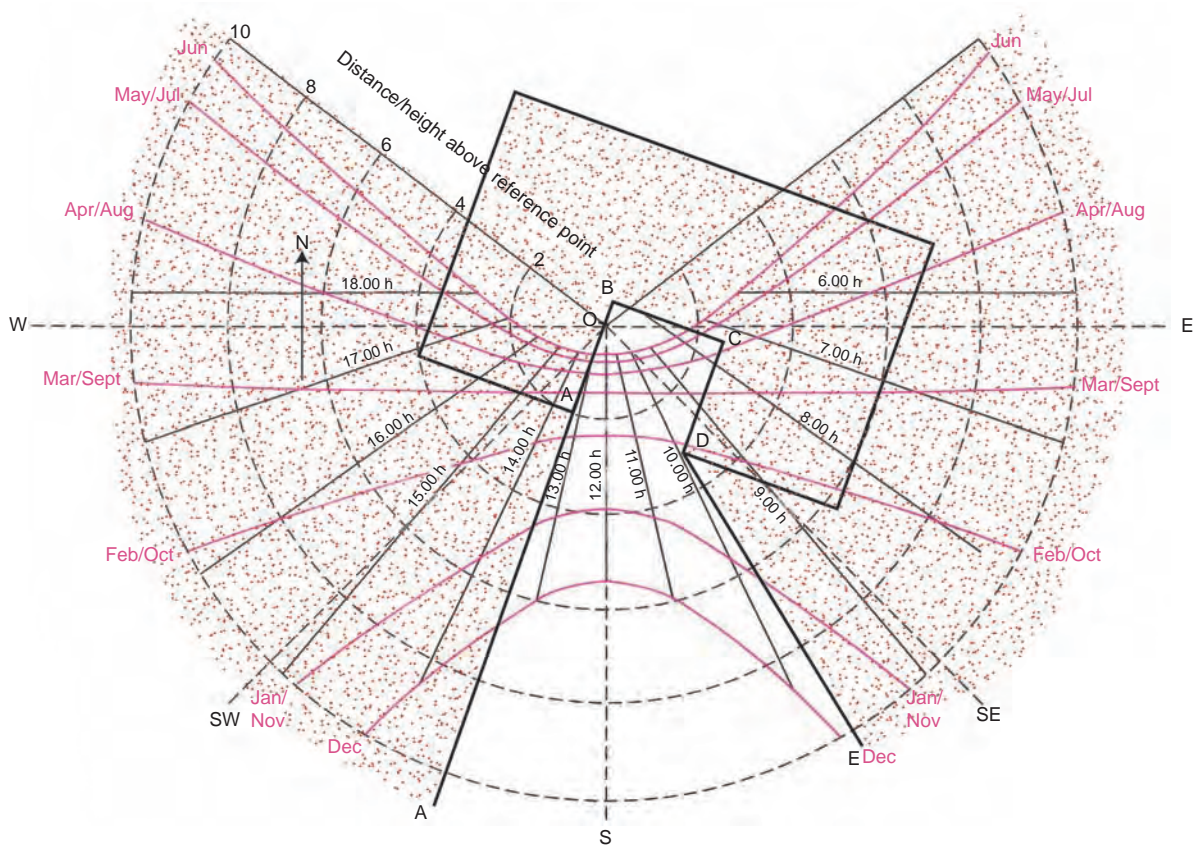

Figure A18: Special site plan (Figure A12) of courtyard layout laid over sunpath indicator

A4.2 The sunpath indicator is used in the same basic way as the sunlight availability indicator. Figure A17 shows the housing layout plot (Figure A10) superimposed on the Edinburgh/Glasgow sunpath indicator (Figure A7). For April/August, May/July and June sunlight will be available at point O from around 08.30 GMT, when the sun appears above wall QR, until just after 15.00, when it goes round past point P in Figure A9. This corresponds to 09.30 until 16.00 BST. In February/October, and March/September there is sun from 09.00 GMT until 16.00. In January/November there is sun for a brief period around 09.30. From 09.40 to 11.40 building IJ blocks it, then from 11.40 onwards the sun is unobstructed until it sets. In December there is sun from 11.40 until sunset.

A4.3 Figure A18 shows this indicator with the special plan of the courtyard layout (Figure A12). In April/August, May/July and June sunlight is available from around 07.30

GMT, when the sun appears over wall BC, until just 13.00 when it no longer can shine on face BOA. In March/September there is sun from 08.50 GMT until 13.00, and in February/October from 09.55 until 13.15. In January/November and December there is sun from 09.45, when it appears around end D of wall CD, until 13.20.

REFERENCES

A1 M E Aizlewood and P J Littlefair. Calculating access to skylight, sunlight and solar radiation on obstructed urban sites in Europe. BRE BR 379. Bracknell, IHS BRE Press, 1999.

A2 BSI. Code of practice for daylighting. BS 8206-2:2008. London, BSI, 2008.

A3 D R G Hunt. Availability of daylight. BRE BR 21. Bracknell, IHS BRE Press, 1979.

APPENDIX B

WALDRAM DIAGRAM TO CALCULATE VERTICAL SKY COMPONENT

B1 As an alternative to the skylight indicator described in Appendix A, a special form of Waldram diagram (Figure B1) can be used to estimate the VSC on an external wall or window. Although it will usually be more time consuming to use than the skylight indicator, the Waldram diagram is more precise and may be used for very complex obstructions. The basic approach is to plot all the obstructions on the diagram; the remaining area is proportional to the sky component on the vertical plane.

B2 Figure B1 is used in the same way as the conventional Waldram diagram for interior daylighting, except that no window outline needs to be plotted as only external surfaces are being considered. Each cm^2 on the Waldram diagram corresponds to 0.1% sky component. Its total area is just under 400 cm^2 corresponding to the sky component of just under 40% on an unobstructed vertical plane.

B3 The horizontal scale on the Waldram diagram is the azimuth angle in degrees from the line perpendicular to the vertical reference plane. The vertical scale is the altitude angle in degrees above the horizontal measured from the reference point on the vertical plane (usually the centre of the window). On the Waldram diagram, vertical edges of obstructions plot as straight vertical lines; horizontal or sloping edges generally plot as curved lines.

B4 To plot a corner of an obstruction or a point on a sloping edge, first measure the angle on the plan at the reference point between the line to the point on the obstruction and the perpendicular to the window wall. This gives the position on the azimuth scale of the Waldram diagram. The position on the altitude scale is given by:

$$\text{Altitude angle} = \arctan (h/d) \text{ degrees}$$

B5 Here h is the height of the point on the obstruction above the reference point, and d is the distance between the two points on plan. In this case, the centre scale of the Waldram diagram should be used, ignoring the droop lines. This altitude angle is not necessarily the same as the angle on any sectional drawing. For example, suppose point B on the roof line of the obstructing building in Figure B2 needs to be plotted; its azimuth angle measured from the plan is 40° . On

plan it is 20 m from the reference point P and it is 8 m above it on section. So its altitude angle is $\arctan (8/20) = \arctan (0.4) = 22^\circ$. These two angles give its coordinates on the Waldram diagram (Figure B3).

B6 The droop lines on the Waldram diagram can be used to plot horizontal edges. The solid droop lines are for edges parallel to the plane of the reference point. The droop line is chosen according to the altitude angle of the horizontal edge in a section perpendicular to the reference window wall. So, for example, in Figure B2 the altitude of the ridge line CD is 30° . It is therefore plotted (Figure B3) along the 30° solid droop line, between azimuth angles corresponding to those of C and D on the plan.

B7 The broken droop lines on the Waldram diagram are used to plot horizontal edges perpendicular to the plane of the reference point. The side FG of the roof of the extension in Figure B2 can be plotted in this way. The required droop line can be chosen by finding the coordinates of any point on the obstructing edge using the method described above. Alternatively if an elevation of the wall containing the reference point is available, the angular altitude of the horizontal edge can be measured off it. The correct droop line is the one which intersects the side of the diagram at that point on the altitude scale. In our example, point G has an altitude of 20° measured on the elevation (Figure B2c Elevation). It is plotted at the far edge of the Waldram diagram in Figure B3 at 20° on the altitude scale. The broken droop line through this point is the edge of the extension FG.

B8 Once all the obstructions have been plotted, measure the remaining area not covered by obstructions (squared tracing paper is ideal for this). This is then divided by 10 to get the VSC. In our example, the unobstructed area on the Waldram diagram (Figure B3) is just over 290 cm^2 . So the VSC is just over 29%.

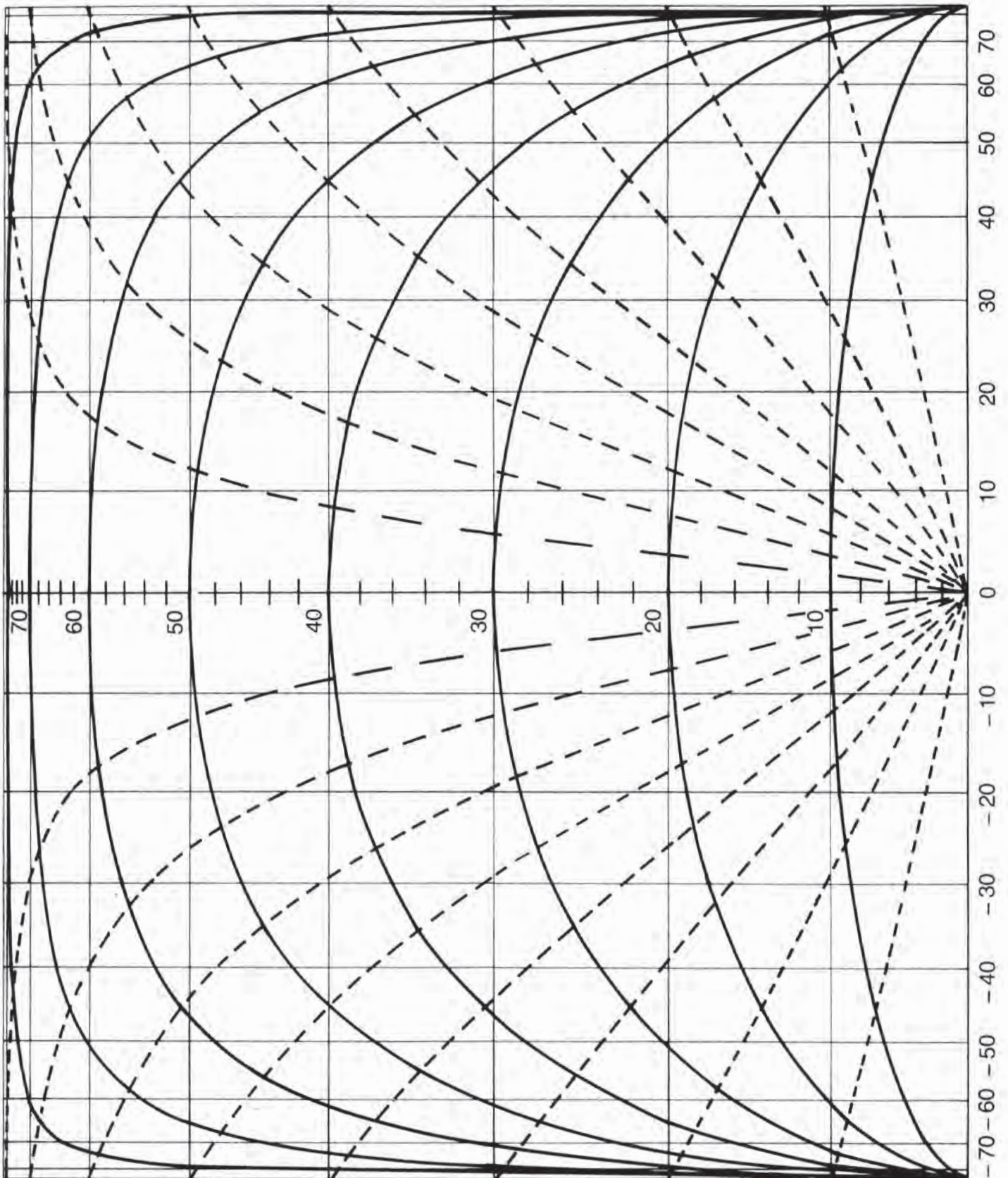
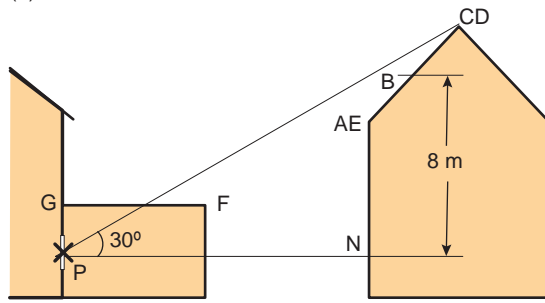
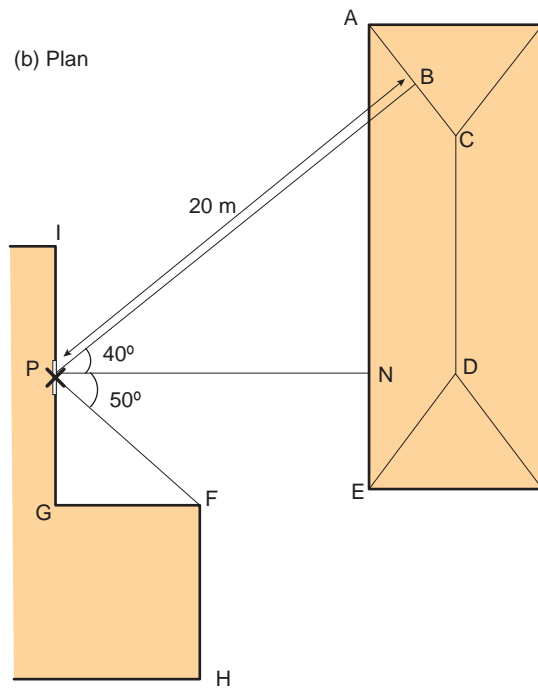

Figure B1: Waldram diagram for calculating VSC

(a) Section



(b) Plan



(c) Elevation

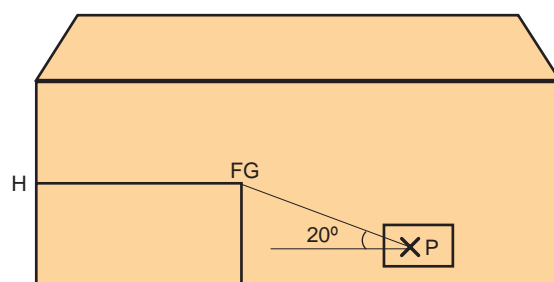

Figure B2: Section, plan and elevation of a (hypothetical) example situation

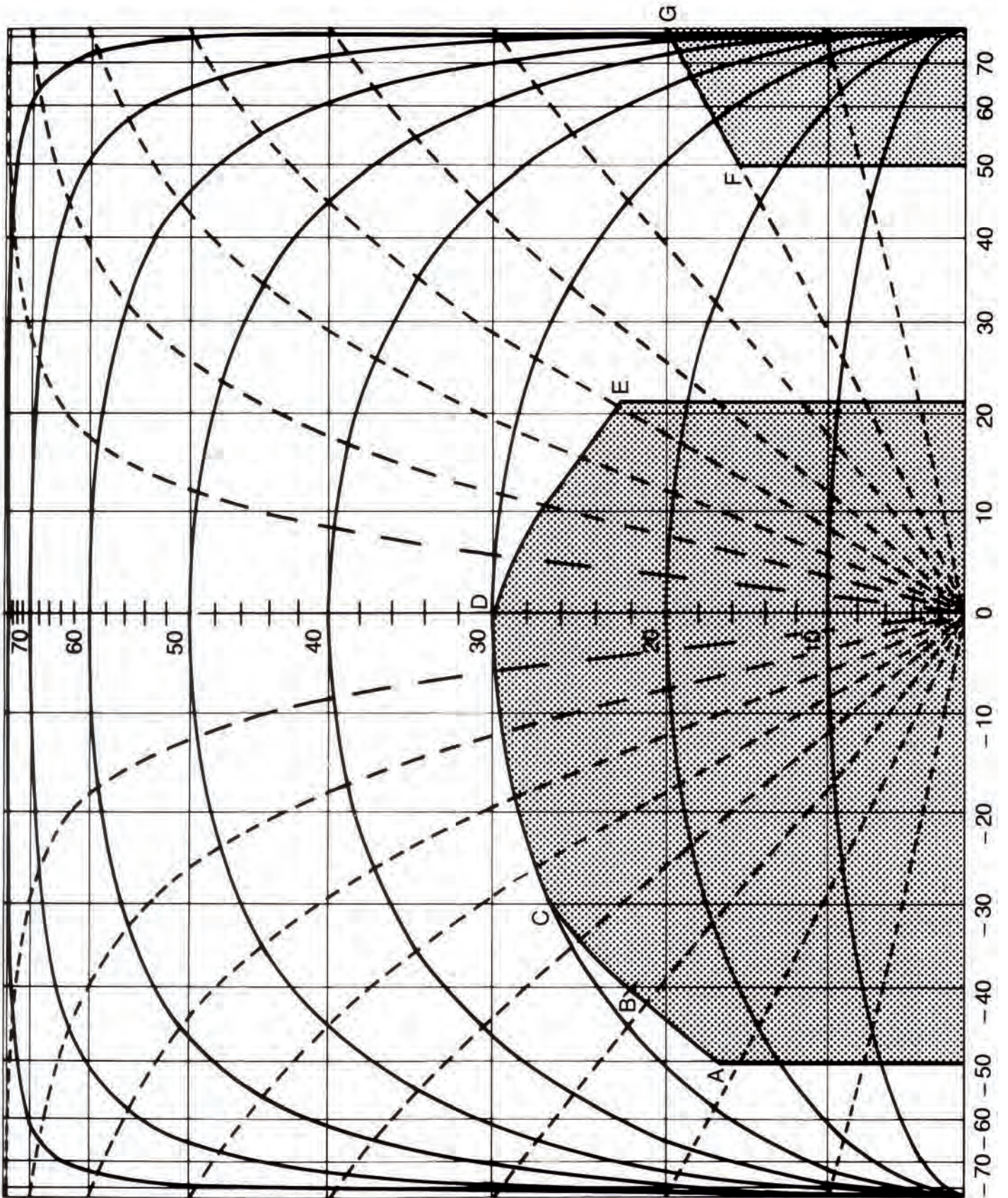

Figure B3: Waldram diagram plot of availability of skylight at point P

APPENDIX C

INTERIOR DAYLIGHTING RECOMMENDATIONS

C1 The British Standard *Code of practice for daylighting* (BS 8206-2)^(C1) and the CIBSE Lighting Guide LG 10 *Daylighting and window design*^(C2) contain advice and guidance on interior daylighting. The guidance contained in this publication (BR 209) is intended to be used with BS 8206-2 and LG 10. Both these publications refer to BR 209.

C2 For skylight BS 8206-2 and LG 10 put forward three main criteria, based on average daylight factor (ADF); room depth; and the position of the no sky line.

Average daylight factor

C3 This is the average illuminance on the working plane in a room, divided by the illuminance on an unobstructed horizontal surface outdoors. The CIE standard overcast sky (see the Glossary) is used, and the ratio is usually expressed as a percentage.

C4 If a predominantly daylit appearance is required, then the ADF should be 5% or more if there is no supplementary electric lighting, or 2% or more if supplementary electric lighting is provided. There are additional recommendations for dwellings of 2% for kitchens, 1.5% for living rooms and 1% for bedrooms. These additional recommendations are minimum values of ADF which should be attained even if a predominantly daylit appearance is not achievable.

C5 ADF can be calculated using the following formula:

$$ADF = \frac{TMA_w \theta}{A(1 - R^2)} \quad \%$$

where:

T is the diffuse visible transmittance of the glazing, including corrections for dirt on glass and any blinds or curtains. For clean, clear double glazing with a low emissivity coating, a value of 0.68 can be used. For other types of glazing, the diffuse transmittance can be found by multiplying the manufacturer's normal incidence light transmittance by 0.91

M is a maintenance factor, allowing for the effects of dirt^(C2)

A_w is the net glazed area of the window (m²)

A is the total area of the room surfaces: ceiling, floor, walls and windows (m²)

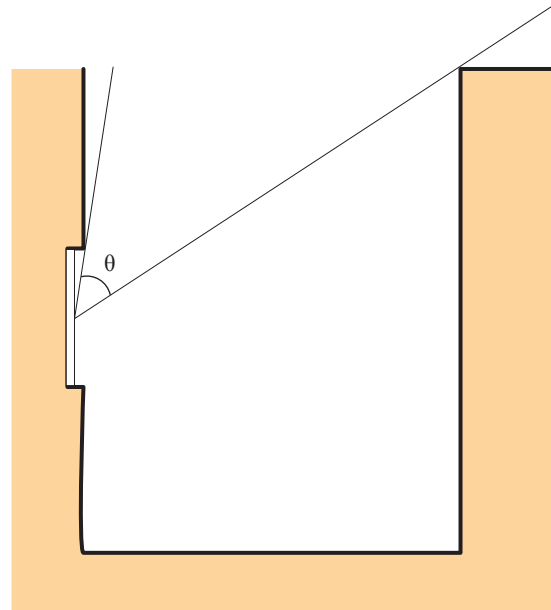

Figure C1: θ is the angle subtended, in the vertical plane perpendicular to the window, by sky visible from the centre of the window

R is their average reflectance. For fairly light-coloured rooms a value of 0.5 can be taken. This value can be used as a default if room reflectances are not known. θ is the angle of visible sky in degrees, measured as shown in Figure C1. It should be measured from a point halfway between the inner and outer faces of the window wall.

C6 Of these quantities, only θ depends on external obstruction. It can be directly related both to the obstruction angle and the vertical sky component (VSC) on the external window wall, as Table C1 shows. In Table C1, no correction has been made for light blocked by the window reveals. This could be done by subtracting the angle subtended by the window wall.

C7 So whatever the shape of any obstruction, it is possible to calculate the VSC at the centre of the window using the skylight indicator (Appendix A) or Waldram diagram (Appendix B), then to find the 'equivalent θ ' from Table C1. This value can be used in the equation to find the ADF for complex obstructions.

Table C1: Values of angle θ for various obstruction angles and VSCs

Obstruction angle, degrees from horizontal (%)	Vertical sky component at centre of window equation	Value of θ in average daylight factor
5	38	85
10	35	80
15	33	75
20	30	70
25	27	65
30	24	60
35	21	55
40	18	50
45	15	45
50	13	40
55	10	35
60	7	30
65	5	25
70	3	20
75	2	15
80	1	10

C8 Reductions in VSC received by the windows of an existing building can also be related to reductions in ADF using Table C1. For example, if the VSC is reduced from 30% to 24% (0.8 times its former value) the value of θ will be reduced from 70 to 60. Thus the ADF is reduced to 60/70 or 0.86 times its former value.

C9 If a room has more than one window, the ADFs due to each one are calculated separately then simply added together.

C10 A special procedure is required for floor to ceiling windows such as patio doors. If part of a window is below the height of the working plane (a horizontal plane 0.85 m above the floor in housing, 0.7 m above the floor in offices), this portion should be treated as a separate window. The ADF for this window has an extra factor applied to it, to take account of the reduced effectiveness of low level glazing in lighting the room. A value equal to the floor reflectance may be taken for this factor, if this is known. If room reflectances are not known, a value of 0.15 can be taken. If the lower part of the window is diffusing (frosted) glass, a value of $R \times (1+R) / 2$ can be taken, where R is the average reflectance of the room surfaces. Thus for $R = 0.5$ the extra factor for diffusing glass would be $0.5 \times 1.5 / 2 = 0.375$. The ADF for the portion of the window above the working plane is calculated in the normal way without this additional factor, and the ADFs for the two portions are added together.

C11 Where windows look into an atrium, the method in BRE Information Paper IP 3/98 *Daylighting in atrium buildings*^(C3) may be used to find the ADF.

C12 Where a rooflight has a continuous obstruction on one side of it, or continuous obstructions on two opposite sides, the angle of visible sky θ can be measured from the section perpendicular to the obstruction(s). If the obstructions are discontinuous or surround the rooflight, the horizontal sky component (HSC) on top of the rooflight can be found using a computer program, or by using BRE daylight protractor^(C4) number 10 to subtract off the sky component blocked by each obstruction in turn (the sky component on an unobstructed rooflight is 100%). The angle of visible sky θ can then be estimated from:

$$\begin{aligned} \text{Angle of visible sky } \theta \\ = 2 \times \text{HSC} + 0.2 \times (100 - \text{HSC}) \text{ degrees} \end{aligned}$$

Room depth

C13 If a daylight room is lit by windows in one wall only, the depth of the room, L should not exceed the limiting value given by:

$$\frac{L}{W} + \frac{L}{H} < \frac{2}{1 - R_b}$$

Where:

W is the room width

H is the window head height above floor level

R_b is the average reflectance of surfaces in the rear half of the room (away from the window).

C14 If L exceeds this value, the rear half of the room will tend to look gloomy and supplementary electric lighting will be required. For a typical room in a house where $W = 4$, $H = 2.4$ and $R_b = 0.5$, the limiting depth L is just over 5 m.

C15 External obstructions do not influence this recommendation. However, there are implications for site layout because the recommendation relates to the maximum depth of a building that can be satisfactorily daylight (twice the limiting depth L , from window wall to window wall).

Position of the no sky line

C16 If a significant area of the working plane (normally more than 20%) lies beyond the no sky line (ie it receives no direct skylight) then the distribution of daylight in the room will look poor and supplementary electric lighting will be required. Appendix D gives guidance on how to plot the no sky line.

C17 Note that the criteria in C14, C15 and C16 need to be satisfied if the whole of a room is to look adequately daylight. Even if the amount of daylight in a room (given by the ADF) is sufficient, the overall daylight appearance will be impaired if its distribution is poor.

Sunlight

C18 For sunlight, follow the recommendation given in BS 8206-2^(C1), as outlined in Sections 3.1 and 3.2.

REFERENCES

- C1 BSI. Code of practice for daylighting. BS 8206-2:2008. London, BSI, 2008.
 - C2 CIBSE. Daylighting and window design. LG10. London, CIBSE, 1999.
 - C3 Littlefair P J and Aizlewood M E. Daylighting in atrium buildings. BRE IP 3/98. Bracknell, IHS BRE Press, 1998.
 - C4 BRE. Daylight protractors. BRE AP 68. Bracknell, IHS BRE Press, 1991.
-

APPENDIX D

PLOTTING THE NO SKY LINE

D1 The no sky line divides those areas of the working plane which can receive direct skylight, from those which cannot. It indicates how good the distribution of daylight is in a room. Areas beyond the no sky line will generally look gloomy.

D2 If the external obstructions already exist, it is possible to measure directly the position of the no sky line in a room. This is best done using a vertical pole such as a small camera tripod, and adjusting its height to that of the working plane. By moving the tripod about, and kneeling or sitting on the floor, and sighting through

the top of the tripod to the window head, it is possible to find the exact places at which the last patches of sky disappear (Figure D1). If furniture or walls make this difficult, a small mirror mounted on the top of the tripod can be used as shown in Figure D2. A convex mirror is easiest to use. The mirror need not be exactly horizontal.

D3 In most cases the position of the no sky line has to be found from plans. Figures D3 to D7 illustrate some common cases. It is usually easiest to have both a plan and section drawn up.

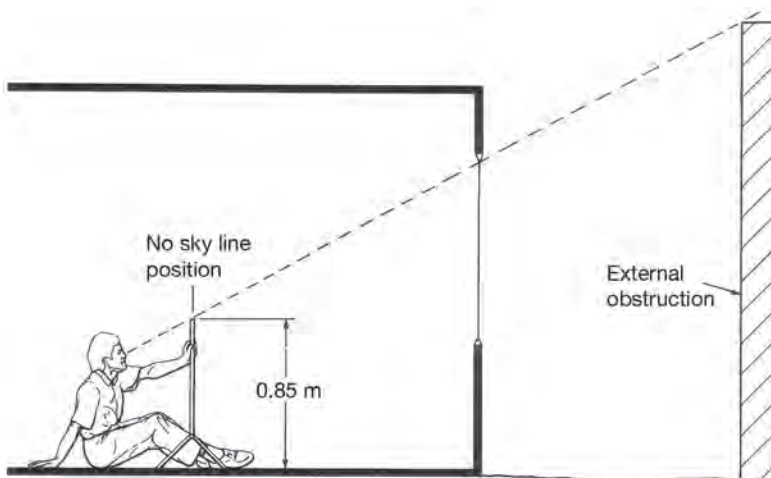

Figure D1: At the no sky line, the last visible patch of sky above the obstructions will just disappear when the window head is sighted through a point at working plane height

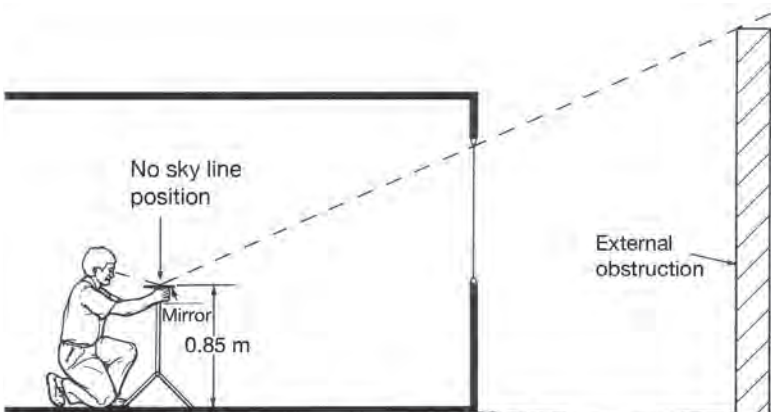

Figure D2: A mirror can be used to sight the no sky line position (compare with Figure D1). A convex mirror is easier to use.

Long horizontal obstruction parallel to window (Figure D3)

D4 The no sky line is also parallel to the window, distant:

$$d = x h / y \text{ from its outside face.}$$

Here:

h is the height of the window head above the working plane

y is the height of the obstruction above the window head

x is its distance from the outside window wall.

D5 If d is greater than the room depth, no part of the room lies beyond the no sky line.

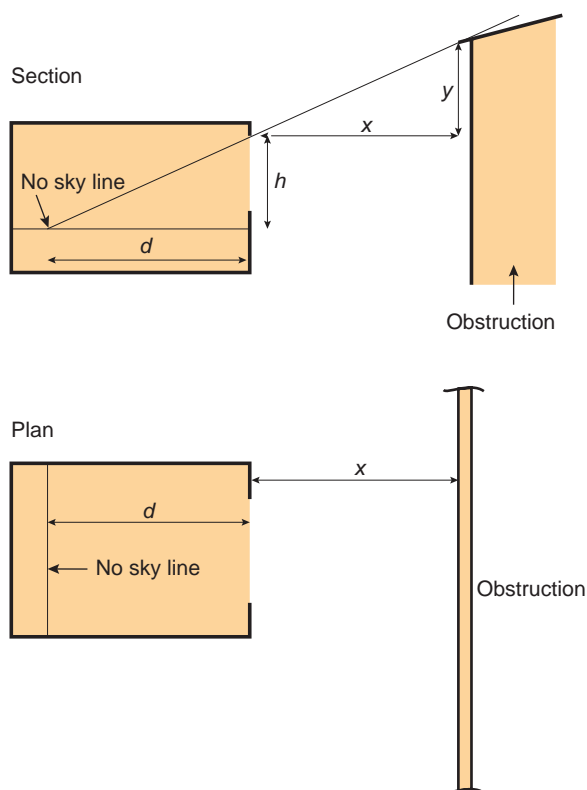

Figure D3: For a long horizontal obstruction parallel to the window, the no sky line is also parallel to the window. Its position can be found from the section.

Narrower horizontal obstruction parallel to window (Figure D4)

D6 Here the obstruction is the same height and distance away as in Figure D3, but it terminates at points A and B. CD is part of the same no sky line as in Figure D3, but now points north of DE can receive light around corner A of the obstruction, and points south of CF can receive light around corner B. So the no sky area is in the form of a trapezium. If the obstruction AB had been even narrower, the no sky area would be triangular in shape, and in the same position even if the obstruction was higher.

D7 In plotting the no sky line the key points are the top corners of the window. These are usually the last points at which sky can be seen.

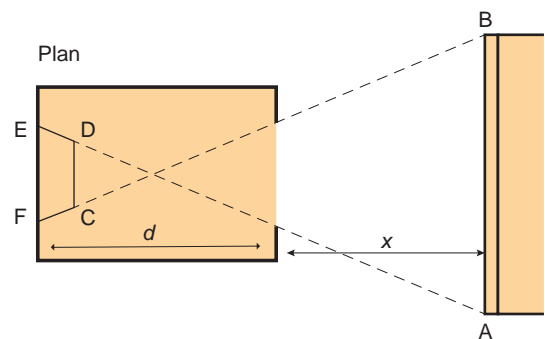
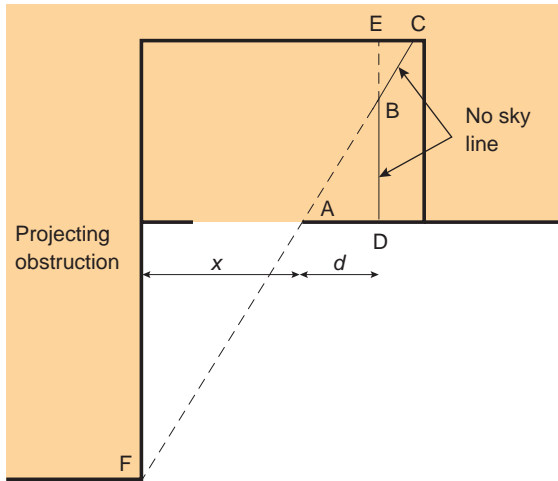

Figure D4: The no sky area for a narrower obstruction is bounded by lines through the centre of the window and the vertical ends of the obstruction

Plan



Elevation

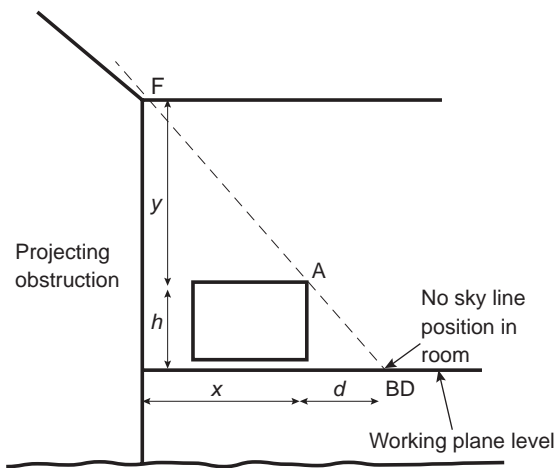

Figure D5: For a horizontal obstruction projecting from the window wall, the no sky line runs partly parallel to the obstruction and partly along a continuation of the line joining the end of the obstruction F and the side of the window A

Horizontal obstruction perpendicular to window wall and projecting from it (Figure D5)

D8 Part of the no sky line (DB) runs parallel to the obstruction. Its distance d from the corner of the window A (the corner furthest from the obstruction) is:

$$d = x h / y$$

Here h is the height of the window head above the working plane.

- y is the height of the obstruction above the window head
- x is the distance on plan from corner A to the obstruction measured along the window wall.

D9 The rest of the no sky line BC is the continuation of the straight line FABC from the end of the obstruction.

Points in the triangle EBC can receive skylight around the corner F; points in the triangle ABD can 'see' sky over the top of the obstruction.

D10 This is a special case of a general rule; if there is a horizontal obstruction at any orientation relative to the window wall, then part of the no sky line will be parallel to the obstruction. Its position is given by:

$$d = x h / y$$

where d and x are the perpendicular distances to the no sky line and the obstruction, measured from the corner of the window furthest from the obstruction (Figure D6).

- h is the height of the window head above the working plane
- y is the height of the obstruction above the window head.

This applies unless the obstruction is too narrow (compare with text in final sentence of paragraph D6).

D11 The analysis of Figures D5 and D6 assumes that the window wall is negligibly thin. If the window wall is thick then the no sky area is larger and part of the no sky line may be curved rather than straight. For example in Figure D5 the no sky line BD would instead curve westwards as it neared the window wall, finally touching it at point A. This only makes a significant difference within around four or five wall thicknesses of the window wall.

More complex situations

D12 These generally occur where there are a number of obstructions which, seen from the interior, appear to lie partly behind each other. A typical example is a row of detached or semi-detached houses with gaps in between (Figure D7). The no sky line PQRSTU VWX is drawn on the room plan. It is a combination of curved and straight lines. In area QRSTU sky is visible above the gap BC; in area VWXY it is visible above the gap DE.

D13 In fact, in this particular case the no sky line is a relatively poor indicator of the daylit appearance of the room. This is because only a very small amount of skylight actually comes through the gaps BC and DE into the room. A better indicator of daylight distribution is the line PY, which would be the no sky line if ABCDE were a continuous terrace. It is of course easier to construct than PQRSTU VWX.

D14 Where there is more than one window, the final no sky line will surround those areas which cannot receive direct skylight from any of the windows. This can be arrived at by considering each window on its own at first, then combining them. In a room with windows on more than one side, it is often the case that all points on the working plane receive direct skylight through one window or another.

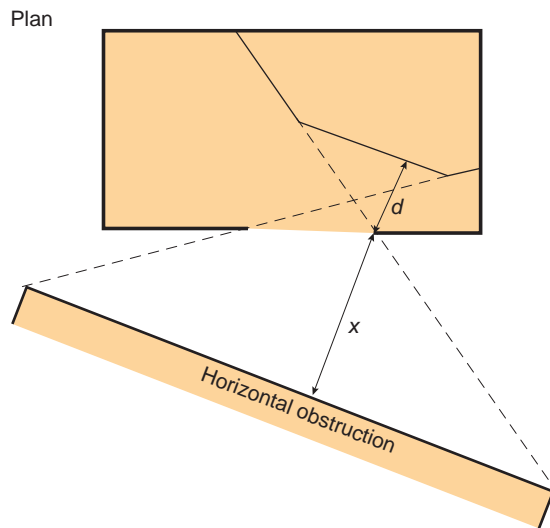

Figure D6: For a general horizontal obstruction, part of the no sky line runs parallel to the obstruction. The rest runs along the projected lines from the ends of the obstruction through the corners of the window.

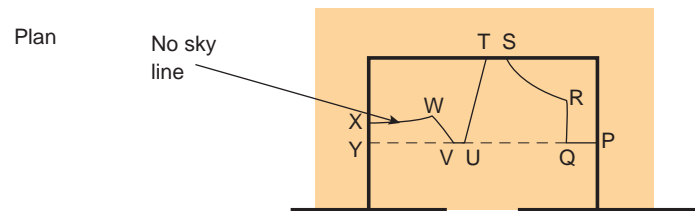

Figure D7: Complex no sky line from a set of obstructions

APPENDIX E

RIGHTS TO LIGHT

E1 The right to light is a legal right which one property may acquire over the land of another. If a building or wall is erected on this land which reduces the light in the obstructed property to below sufficient levels, then the right to light is infringed. The owner or tenant of the obstructed property may seek legal redress, for removal of the obstruction and/or damages. Recent case law has demonstrated how this can result in considerable expense, involving demolition of large parts of recently constructed buildings. It is prudent therefore to consider the question of rights of light at the design stage.

E2 A full explanation of rights of light is outside the scope of this guide. Guidance on rights of light is given in a number of textbooks^[E1-E5] and by the RICS^[E6-7].

E3 A right to light can be acquired by a legal agreement, or under the terms of the Prescription Act of 1832 if the light has been enjoyed without interruption for at least 20 years. If the light is obstructed for more than a year then the right may be lost under the Prescription Act, but caution should be exercised as there may still be an action taken (under Lost Modern Grant^[E2]). Sometimes, if windows have received light over adjoining land for nearly 20 years, the owner of the adjoining land may register a Notice of Notional Obstruction under the 1959 Rights of Light Act. This is a way of preventing the windows from acquiring a right to light over the land when the 20 years has expired. A right to light can also be rescinded by a legal agreement, usually with compensation to the owner of the property whose light is lost.

E4 The right to light is for light from the sky alone; no right to sunlight exists, although there is a precedent for removal of obstructions to a greenhouse. Nor is there a right to a view. Also, the right is only to the amount of light that is 'sufficient for ordinary purposes' and does not compare directly with the recommendations in the BS 8206-2^[E8] (see Appendix C).

E5 The accepted way of calculating the loss of light is to compute the sky factor at a series of points on the working plane. In dwellings, the working plane height is usually taken to be 0.85 m (two feet nine inches). The sky factor is the ratio of the illuminance directly

received from a uniform sky at the point indoors, to the illuminance outdoors under an unobstructed hemisphere of this sky. No allowance is made for glass losses or light blocked by glazed bars and (usually) window frames; nor is reflected light included, either from interior surfaces or obstructions outside. Thus the sky factor is not the same as the CIE daylight factor (see Appendix C). The sky factor is often calculated using a Waldram diagram^[E9], but this is a different Waldram diagram to Figure B1 in Appendix B, which should not be used for this purpose.

E6 The approach used in previous court cases^[E1-E3] has been to plot the 0.2% sky factor contour in the room, both before and after the new obstruction is erected. Figure E1 shows an example. The areas of the room which lie beyond these 0.2% contours 'before' and 'after' are then found. (Note that the 'before' condition should include any obstructions previously on the adjoining site.) According to legal precedent, if more than half a room has a sky factor of less than 0.2%, then the room as a whole is inadequately lit. This is not a hard and fast rule, and in one case a room was deemed inadequately lit even though slightly less than half of it had a sky factor of less than 0.2%. One important factor is whether the proposed new building is one of a number of possible future obstructions which might further reduce the light in the existing room.

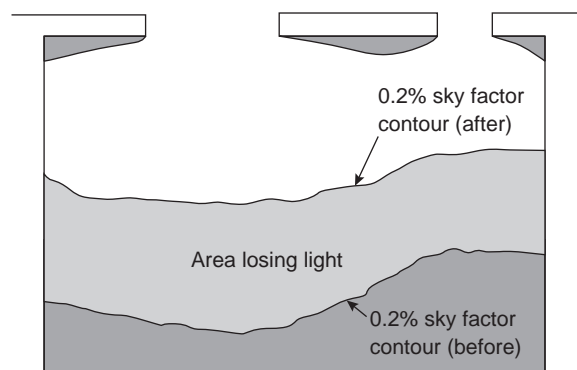

Figure E1: Plan of room showing movement of the 0.2% sky factor contour following erection of an obstruction

E7 The area with a sky factor less than 0.2% will always be greater than the area of the room beyond the no sky line (Appendix D). Thus if more than half of the room is beyond the no sky line with the new development in place, it follows automatically that more than half the room will have a sky factor below 0.2%.

E8 As a general guide, currently if after construction of a proposed development more than half of a room in an existing building has a sky factor of less than 0.2%, and a right to light exists, then this right will probably be infringed. Developers should exercise extreme caution as the law in this area is very complex and they should seek expert advice. The risks of an injunction being granted are considerable, particularly if complaints from adjoining owners are ignored.

E9 There is currently an active debate by experts in the field of rights to light regarding the legal measure of adequacy^[E10-E13] and this may result in a change in approach within the next few years. This debate concerns the use of a non-uniform (CIE overcast sky) in the calculation process, the 0.2% value for the criterion, and the use of the working plane at 0.85 m.

REFERENCES

- E1 Anstey J and Harris L. Anstey's rights of light. London, RICS, 2006.
- E2 Bickford Smith S and Francis A. Rights of light: the modern law. Bristol, Jordans, 2007.
- E3 Ellis P. Rights to light. London, Estates Gazette, 1989.
- E4 Hannaford S, Stephens J and O'Hagan R. Rights to light. Coventry, RICS Books, 2008.
- E5 Redler A. Practical neighbour law handbook. London, RICS, 2006.
- E6 RICS. A clear impartial guide to right to light. London, RICS, 2008.
- E7 RICS. Rights of light – Practical guidance for chartered surveyors in England and Wales. London, RICS, 2010.
- E8 BSI. Code of practice for daylighting. BS 8206-2:2008. London, BSI, 2008.
- E9 Hopkinson R G, Petherbridge P and Longmore J. Daylighting. London, Heinemann, 1966.
- E10 Defoe P S and Frame I. Was Waldram wrong? Structural Survey Journal, 2007, 25 (2): 98–116.
- E11 Defoe P S. Waldram was wrong! Structural Survey Journal, 2009, 27 (3): 186–199.
- E12 Pitts M. The grumble point is it still worth the candle? Structural Survey Journal, 2000, 18 (5): 255–258.
- E13 Chynoweth P. Progressing the rights to light debate part II: the grumble point revisited. Structural Survey Journal, 2005, 23 (4): 251–264.

APPENDIX F

SETTING ALTERNATIVE TARGET VALUES FOR SKYLIGHT AND SUNLIGHT ACCESS

F1 Sections 2.1, 2.2 and 2.3 give numerical target values in assessing how much light from the sky is blocked by obstructing buildings. These values are purely advisory and different targets may be used based on the special requirements of the proposed development or its location. Such alternative targets may be generated from the layout dimensions of existing development, or they may be derived from considering the internal layout and daylighting needs of the proposed development itself.

F2 Sometimes there may be an extant planning permission for a site but the developer wants to change the design. In assessing the loss of light to existing windows nearby, a local authority may allow the vertical sky component (VSC) and annual probable sunlight hours (APSH) for the permitted scheme to be used as alternative benchmarks. However, since the permitted scheme only exists on paper, it would be inappropriate for it to be treated in the same way as an existing building, and for the developer to set 0.8 times the values for the permitted scheme as benchmarks.

F3 Whatever the targets chosen for a particular development, it is important that they should be self-consistent. Table F1 can be used to ensure this. First a limiting obstruction angle (for wide obstructions) is chosen from the first column. The second column expresses this as the ratio (spacing of obstruction)/ (height above reference point). The third column gives the equivalent VSC at the reference point; this can be used to assess the skylight impact of taller, narrower obstructions. The remaining three columns give the corresponding quantities which can be used to assess the amount of skylight left to reach adjoining development land (Section 2.3). They are derived from the building-to-building angles in the first column, by using the method illustrated in Figure 12 of Section 2.3, which constructs an imaginary 'mirror image' building the other side of the boundary. Again all angles and heights are expressed relative to a reference point which would normally be at the level of the lowest window.

F4 For example, in a mews in a historic city centre, a typical obstruction angle from ground floor window level might be close to 40° (Figure F1). This would correspond to a VSC of 18%, which could be used as a target value for development in that street if new development is to match the existing layout.

F5 A similar approach may be adopted in cases where an existing building has windows that are unusually close to the site boundary and taking more than their fair share of light. Figure F3 shows an example, where side windows of an existing building are close to the boundary. To ensure that new development matches the height and proportions of existing buildings, the VSC and APSH targets for these windows could be set to those for a 'mirror-image' building of the same height and size, an equal distance away on the other side of the boundary.

F6 In assessing the loss of light to an existing building, the VSC is generally recommended as the appropriate parameter to use. This is because the VSC depends only on obstruction, and is therefore a measure of the daylight environment as a whole. The average daylight factor (ADF) (Appendix C) also depends on the room and window dimensions, the reflectances of interior surfaces and the type of glass, as well as the obstructions outside. It is an appropriate measure to use in new buildings because most of these factors are within the developer's control.

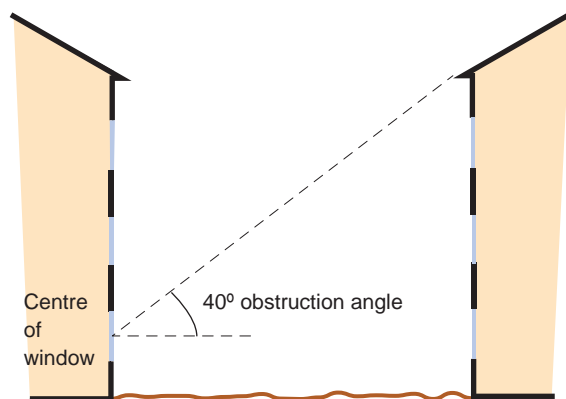

Figure F1: Hypothetical example of a narrow mews with a higher obstruction angle

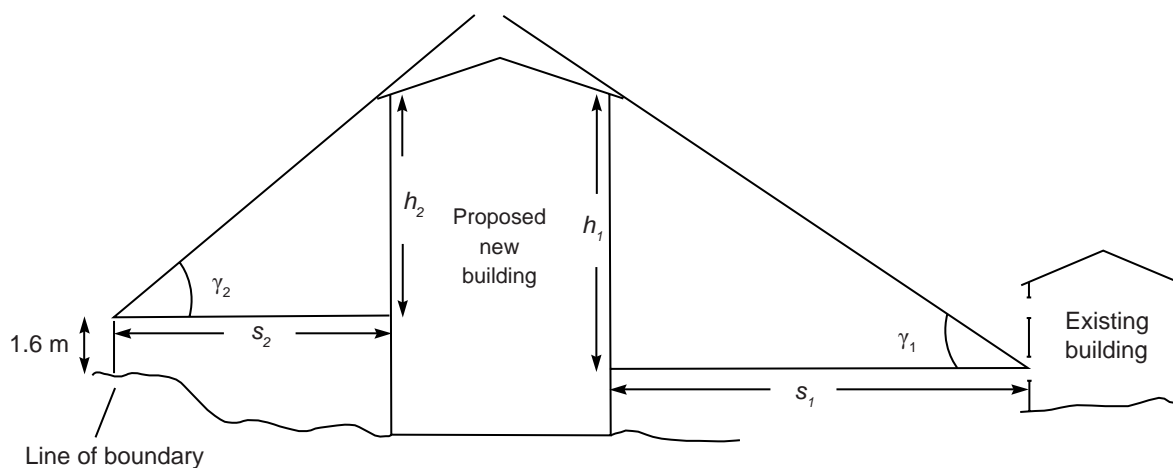

Figure F2: Angles, spacings and heights used in Table F1

Table F1: Equivalent VSCs, spacing-to-height ratios and boundary parameters corresponding to particular obstruction angles between rows of buildings. (Heights and angles are usually relative to a point at the centre of a window, see Figure F2.)

Obstruction angle γ on building, degrees to horizontal	Equivalent spacing-to-height ratio (s_1/h_1)	Equivalent vertical sky component (VSC) (%)	Obstruction angle γ_1 at boundary (degrees to horizontal)	Spacing from boundary, divided by height (s_2/h_2)	Vertical sky component at boundary (%)
16	3.5	32	30	1.7	24
18	3.1	31	33	1.5	23
20	2.7	30	36	1.4	21
22	2.5	29	39	1.2	19
24	2.2	28	42	1.1	17
25	2.1	27	43	1.1	17
26	2.1	27	44	1.0	16
28	1.9	26	47	0.93	14
30	1.7	24	49	0.87	13
32	1.6	23	51	0.81	12
34	1.5	22	53	0.75	11
36	1.4	21	55	0.69	10
38	1.3	20	57	0.64	9
40	1.2	18	59	0.60	8
42	1.1	17	61	0.56	7
44	1.0	16	63	0.52	6
46	1.0	15	64	0.48	6
48	0.90	14	66	0.45	5
50	0.84	13	67	0.42	4

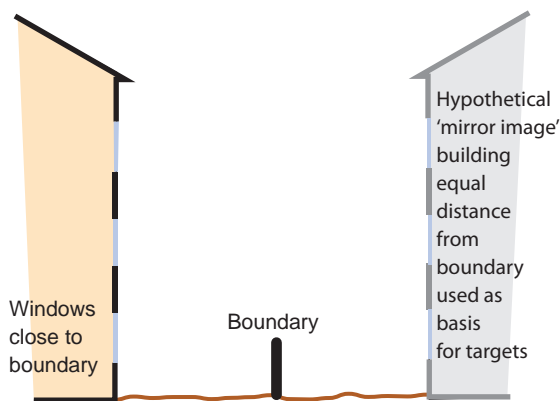

Figure F3: Use of a hypothetical mirror image building to set target daylight values

F7 Use of the ADF for loss of light to existing buildings is not generally recommended. The use of the ADF as a criterion tends to penalise well-daylit existing buildings, because they can take a much bigger and closer obstruction and still remain above the minimum ADFs recommended in BS 8206-2^{F1}. Because BS 8206-2 quotes a number of recommended ADF values for different qualities of daylight provision, such a reduction in light would still constitute a loss of amenity to the room. Conversely if the ADF in an existing building were only just over the recommended minimum, even a tiny reduction in light from a new development would cause it to go below the minimum, restricting what could be built nearby.

F8 However, there are some situations where meeting a set ADF target value with the new development in place could be appropriate as a criterion for loss of light:

- (i) where the existing building is one of a series of new buildings that are being built one after another, and each building has been designed as part of the larger group

- (ii) as a special case of (i), where the existing building is proposed but not built. A typical situation might be where the neighbouring building has received planning permission but not yet been constructed
- (iii) where the developer of the new building also owns the existing nearby building and proposes to carry out improvements to the existing building (eg by increasing window sizes) to compensate for the loss of light. However, where there is a long-term occupier of the existing building it would be appropriate for there to be no reduction in ADF, or at worst only a small reduction. BS 8206-2 states that a reduction in VSC to 0.8 times its former value corresponds to a reduction in the ADF in the room served by the window to between 0.85 times and 0.92 times its former value when the original VSC was >27% or 5%, respectively
- (iv) where the developer of the new building also owns the existing nearby building and the affected rooms are either unoccupied or would be occupied by different people following construction of the new building.

F9 Notwithstanding the above guidance, the developer should still be aware of the rights to light of adjoining properties, as the higher levels of obstruction resulting from such a flexible approach may result in infringement of rights to light (see Appendix E).

REFERENCE

F1 BSI. Code of practice for daylighting. BS 8206-2:2008. London, BSI, 2008.

APPENDIX G

CALCULATION OF SUN ON THE GROUND

G1 A set of 12 transparent indicators, *Sun-on-ground indicators*^(G1), are available separately, and can be used to predict the availability of sunlight on the ground at the equinox (21 March). The indicators are for three different latitudes and for use with four different scales of plan (1:100, 1:200, 1:500 and 1:1250). It is important to use the right indicator for each location and especially for the scale of plan used. If the available plan is drawn to a different scale, the indicator may be modified by changing its height scale. For example, a 1:50 scale indicator may be created by taking the 1:100 indicator and dividing each of the heights by two.

G2 The indicators are calculated for latitudes of 51.5°N (London), 53.5°N (Manchester) and 56°N (Edinburgh/Glasgow). The London indicators may be used for southern England, and the Manchester ones for northern England, north Wales and the southern half of Northern Ireland. For Scotland and the northern half of Northern Ireland, use the Edinburgh/Glasgow indicators.

G3 Unlike the indicators in Appendix A, the sun-on-ground indicator can be laid directly onto a plan of that particular scale. In use, the indicator must always be aligned with its south point corresponding to due south on the plan.

G4 Figure G1 illustrates an example garden. Point P at the centre top of the indicator (Figure G2) is placed at the reference point on the plan where the sunlight needs to be calculated. As a first check for a simple space like a rectangular garden, the centre of the garden can be taken. For an L-shaped garden, the location of the centre is worked out in the following way. Calculate the total area of the garden. The distance x in Figure G1 is equal to the garden area divided by twice its length (L). The distance y in Figure G1 is the garden area divided by twice its width (W). For example, suppose L is 20 m and W is 8 m, and the extension is 8 m long by 4 m wide. The total area of the garden is $20 \times 8 - 8 \times 4 = 128 \text{ m}^2$. The distance x is $128 / (2 \times 20) = 3.2 \text{ m}$. The distance y is $128 / (2 \times 8) = 8 \text{ m}$. So the centre of the garden is 8 m from the far end of it, and 3.2 m from the side opposite the extension.

G5 The radial lines fanning out from point P give the directions of the sun at 15 min intervals through the day. The topmost radial lines (labelled '10° line') give the directions at which the sun's altitude is 10°. Sunlight coming from below this angle is usually discounted as it is likely to be prevented from reaching the ground by fences, plants or other low level obstructions.

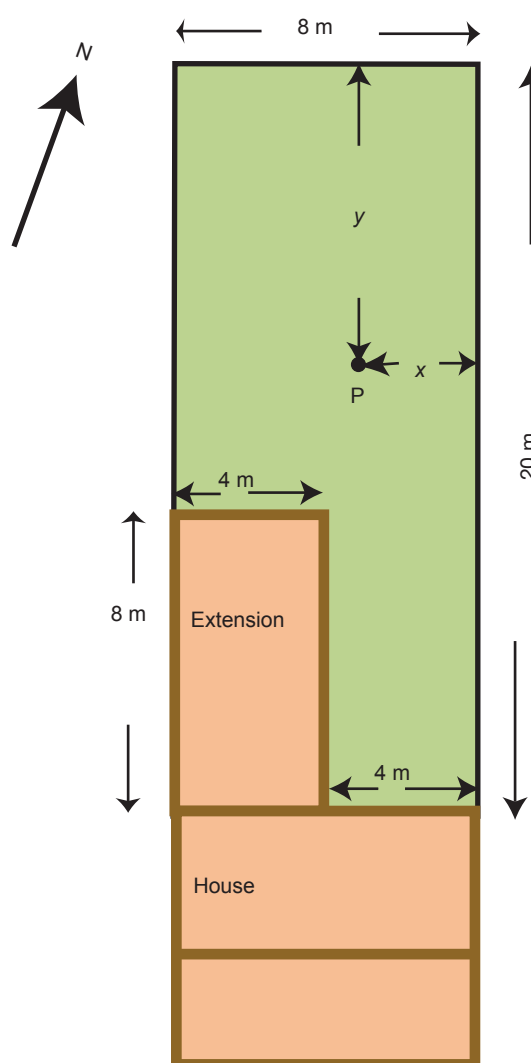

Figure G1: Plan of an example garden showing centre point

London 51.5° N

Scale 1:100

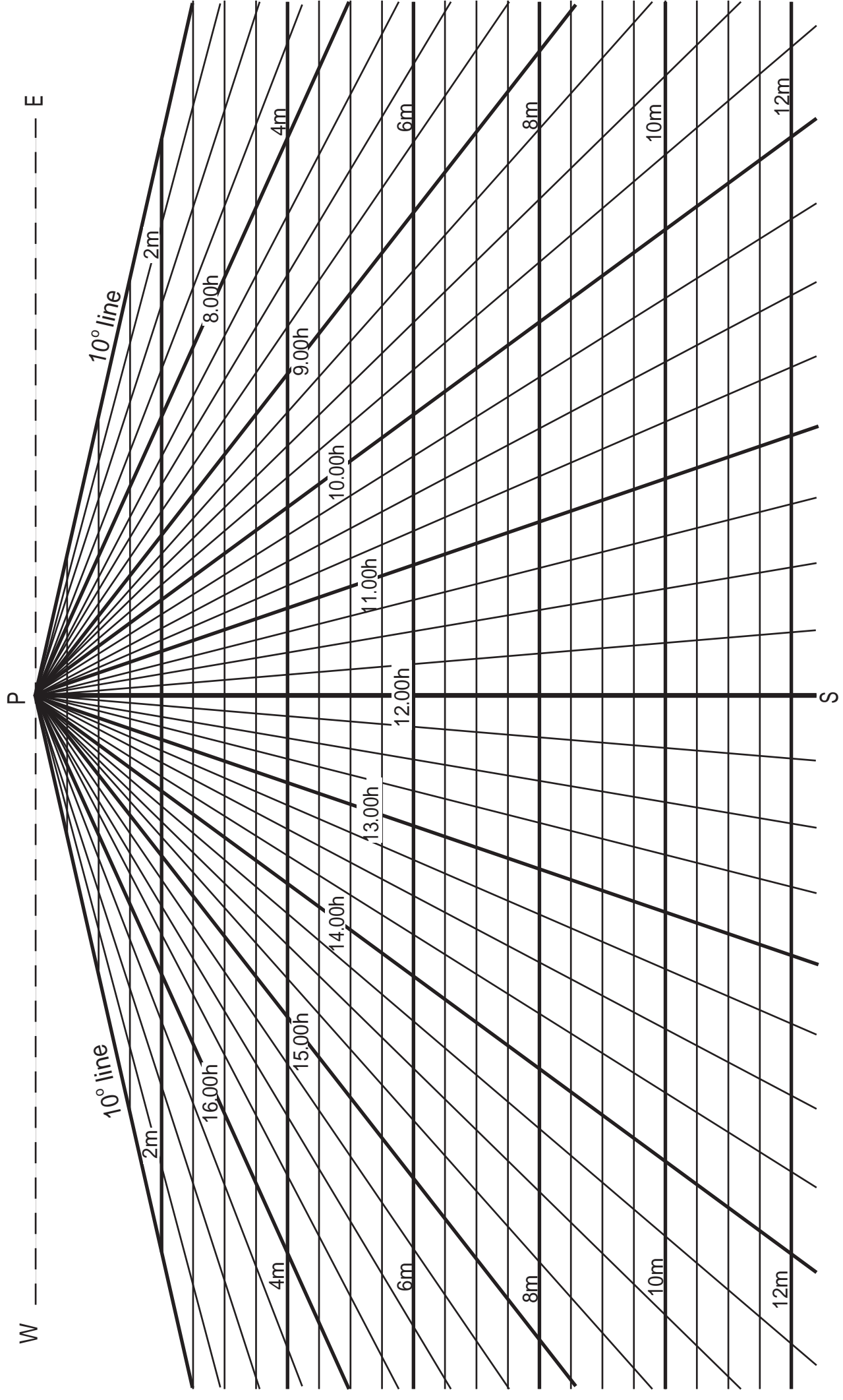
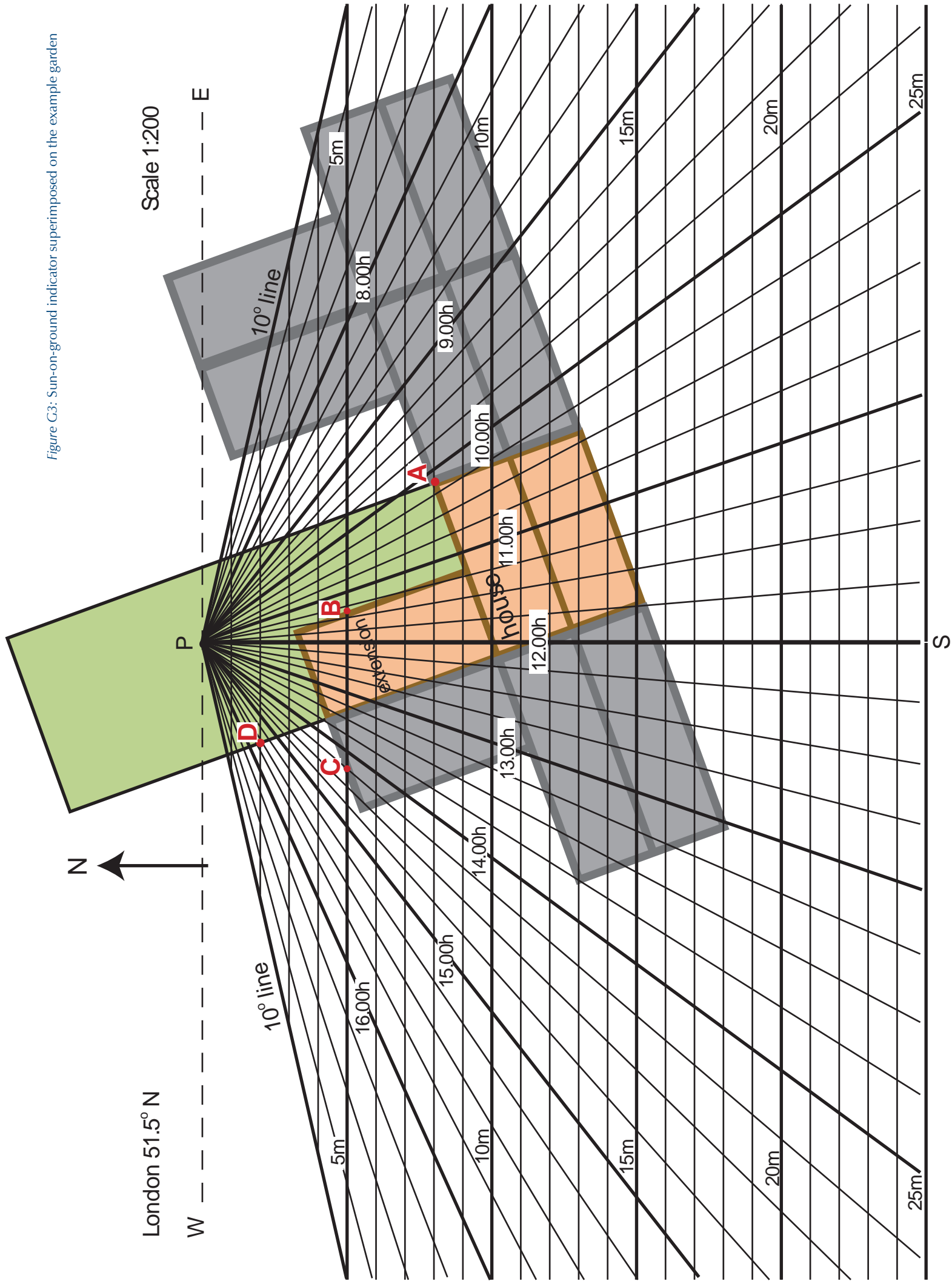

Figure G2: Sun-on-ground indicator for 21 March (for southern England and south Wales, scale 1:100)

Figure C3: Sun-on-ground indicator superimposed on the example garden



G6 The horizontal lines running across the indicator give the height of obstructions which would just stop the sun from shining on point P at each time of day. These heights are relative to the point on the ground. On sloping ground, take care that the height used is the actual height of the top of the obstruction above the particular reference point.

G7 To find the hours of sunshine on 21 March at a particular reference point, lay the correctly scaled indicator on the plan, with point P at the reference point, and the south line pointing due south. For each obstruction compare its height above the reference point with the height on the corresponding horizontal line on the indicator. If the obstruction is higher it will block sunlight at the time of day indicated by the hour lines.

G8 Figure G3 illustrates the use of the indicator to calculate the times point P, at the centre of the garden in example Figure G2, can receive sunlight. The site is in southern England, so one of the London indicators has been used. Other houses and garden walls that could block sunlight have been included in the plan. The garden walls are 2 m high. The extensions are all 5 m high and flat roofed; the houses are 8 m high at the eaves, with ridges 10 m high.

G9 The sun-on-ground indicator is laid over the plan. The 1:200 indicator is used because that is the scale of the plan. The centre of the indicator is at point P and the indicator is aligned correctly north-south (*this is very important*).

G10 The 8 m high eaves of the neighbouring houses to the east will block sunlight until it reaches point A. This is the point where the eaves line meets the 8 m line on the sun-on-ground indicator. It corresponds to just after 10.00. After this time there is sunlight over the house (the 10 m high ridge will not block the sun because it is beyond the 10 m line on the indicator). Sunlight is

blocked again at just after 11.15, when the 5 m high extension meets the 5 m line on the indicator (point B). The extension, and the next door neighbour's extension to the west, blocks sun until 14.15 (point C), when the 5 m line of the indicator again intersects the extension. Finally sunlight is blocked from 15.30 onwards by the 2 m high fence, after it intersects the 2 m line on the indicator.

G11 The net result is that point P receives over two hours of sunlight (just over one hour in the morning, and just over one hour in the afternoon).

G12 Another use of the sun-on-ground indicator is to plot the course of the shadows cast by a building throughout the day. This is especially valuable for a large development which may overshadow a number of neighbouring properties. Again a plan of the scale marked on the indicator is required, but this time the indicator is used in reverse. Place point P on the indicator at each point on the roofline of the building in turn. The south (noon) point on the indicator must point due north, because shadows will be cast in this direction at midday. Then the direction of the shadow cast by the point on the roofline at a particular time of day is the direction of the hour line. The shadow ends where this hour line intersects the height line corresponding to the height of the point on the roof line above the ground at the end of the shadow.

G13 Figure G4 gives the outline plan and elevation of a simple example: a medium-sized office block with an atrium. Figure G5 illustrates the use of the indicator to determine the shadow cast by point C at the apex of the atrium roof, at 10.00 on 21 March. Point P on the indicator is placed on point C on the plan. As point C is 16 m above the ground its shadow falls at point C' where the 10.00 hour line intersects the 16 m height line. Point C' is marked on the plan and the procedure then repeated for points A, B, D and E on the roof line. The resulting shadow is found by simply joining the dots

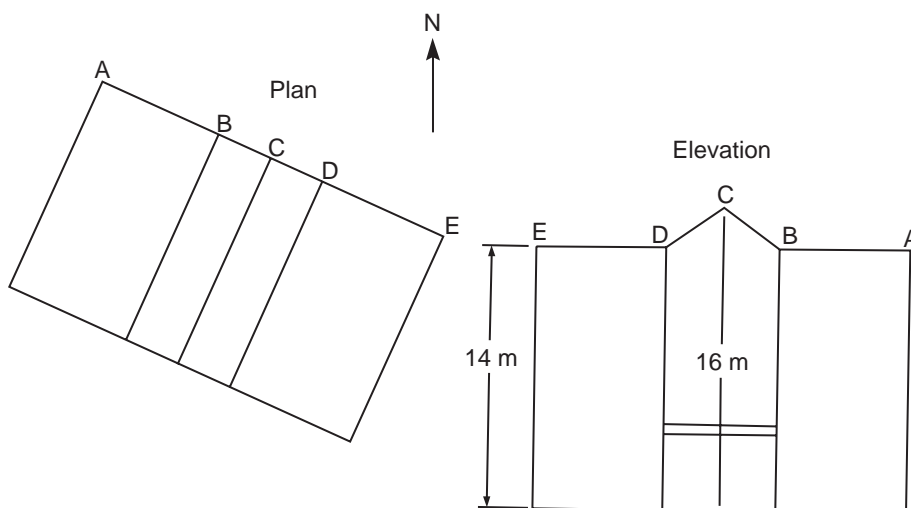

Figure G4: Outline plan and elevation of a shadow plotting example building

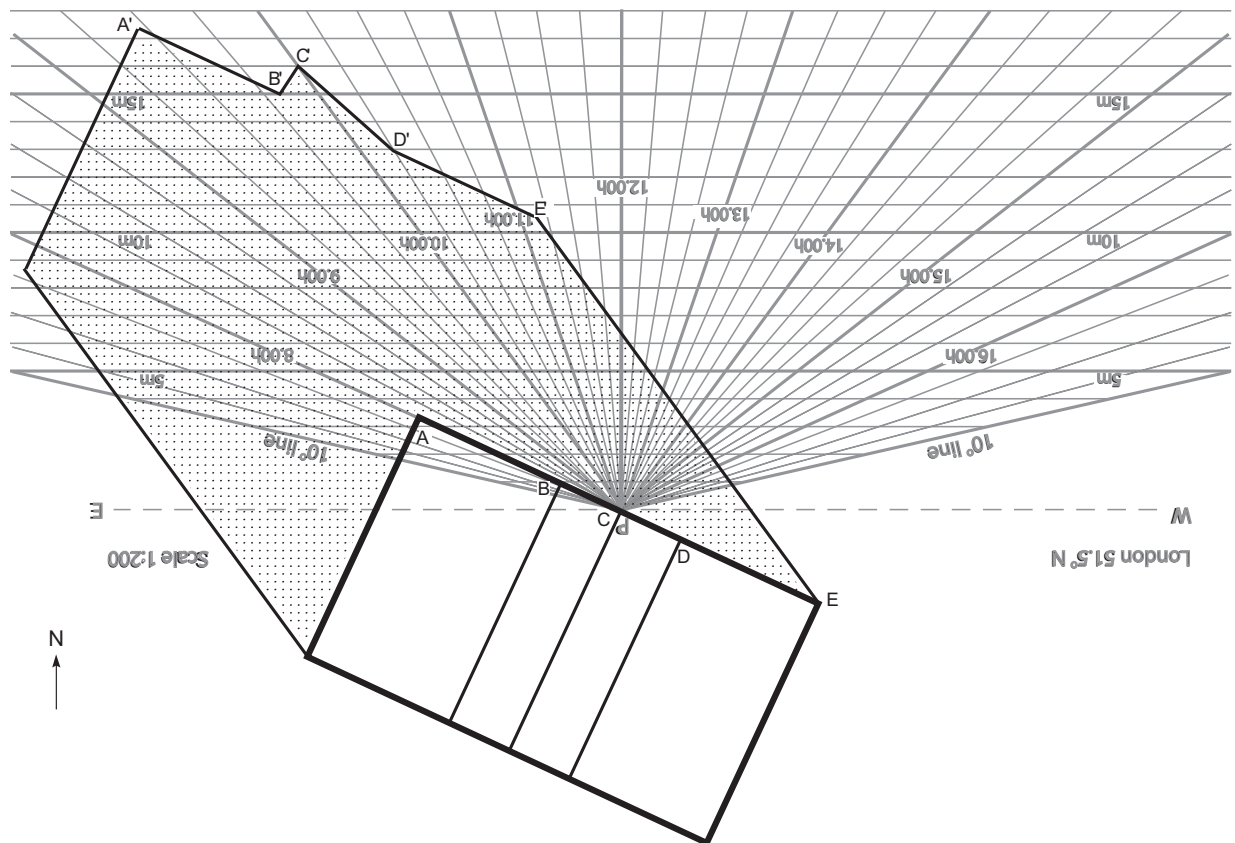

Figure G5: Use of the sun-on-ground indicator to plot the shadow of the example building in Figure G4 on 21 March

(Figure G5). Note that the shadows of vertical edges should be parallel to the hour line. The method can be repeated for different times to build up a diurnal profile of shadowing at the equinox.

G14 Note that the examples above have assumed level ground next to the building. If the ground slopes significantly, the building heights are heights above the point on the ground where the shadow is falling. A trial

and error approach with the indicator may be necessary. If the ground is terraced, stepping down from one level to another, shadow plotting may be repeated for each level and the results juxtaposed on plan.

REFERENCE

G1 BRE. Sun-on-ground indicators. BRE AP 288. Bracknell, IHS BRE Press, 2011.

APPENDIX H

TREES AND HEDGES

H1 INTRODUCTION

H1.1 Trees and hedges vary in their effects on skylight and sunlight. Most tree species will cast a partial shade^[H1,H2]; for deciduous trees this will vary with time of year. However, very little light can penetrate dense belts of evergreen trees, and the shade they cause will be more like that of a building or wall.

H1.2 It is generally more difficult to calculate the effects of trees on daylight because of their irregular shapes and because some light will generally penetrate through the tree crown. Where the effect of a new building on existing buildings nearby is being analysed, it is usual to ignore the effect of existing trees. This is because daylight is at its scarcest and most valuable in winter when most trees will not be in leaf.



Figure H1: Using a clinometer to measure tree height

H2 SKYLIGHT IN NEW DWELLINGS OBSTRUCTED BY TREES

H2.1 Sometimes, however, trees should be taken into account, eg where a new dwelling is proposed near to large existing trees. There may be concern that future occupants of the dwelling may want the trees to be cut down if they block too much skylight or sunlight.

H2.2 A way to assess this is to calculate the average daylight factor (ADF) in the proposed rooms with the trees in place. This will depend on the transparency of the trees; the proportion of light that passes through the tree crown.

H2.3 As a first step, calculate the vertical sky component (VSC) at the centre of each window (eg by using the skylight indicator (Figure A1) in Appendix A, or Waldram diagram (Figure B1) in Appendix B), assuming the trees are completely opaque at all times. This needs to be done using the exact shape of the trees; often trees are irregularly shaped and simple modelling, using height and spread data and assuming a circular tree, will give inaccurate results. A special survey on site is generally required to produce the required data on the tree profile, using a clinometer or similar device to measure tree height (Figure H1). The effects of obstruction by buildings should also be taken into account.

H2.4 From the calculated VSC at the centre of the window, the equivalent visible sky angle θ with opaque trees may be found, using Table C1 in Appendix C. This value of θ will underestimate the amount of daylight available. In practice, some skylight will pass through the tree crowns and reach the windows. Therefore, the calculation of VSC and θ should be repeated assuming there are no trees, only buildings. The effective value of θ is then given by:

$$\theta \text{ with trees} = \theta \text{ with opaque trees} + \frac{\text{transparency}}{100\%} \times (\theta \text{ with no trees} - \theta \text{ with opaque trees})$$

H2.5 Table H1 contains data^[H3,H4] on the optical transparency of tree crowns for winter and summer.

H2.6 Because there are two different values of transparency for winter and summer, there will be two different values of equivalent visible sky angle θ . These values are then used in the ADF equation in Appendix C to give two different ADFs, in winter and in summer.

H2.7 Thus in an interior shaded by deciduous trees, the ADF will change from season to season. In the summer, when the trees are in leaf, the ADF will be lower than in winter. It could be argued that skylight provision is more important in winter. Outdoor illuminances are lower then, so less light would be available.

Table H1: Transparencies of tree crowns to solar radiation

Botanical name	Common name	Transparency (% radiation passing)	
		Full leaf	Bare branch
<i>Acer pseudoplatanus</i>	Sycamore	20	60
<i>Acer saccharinum</i>	Silver maple	15	55
<i>Aesculus hippocastanum</i>	Horse chestnut	20	55
<i>Betula pendula</i>	European birch	20	55
<i>Fagus sylvatica</i>	European beech	20	45*
<i>Fraxinus exelsior</i>	European ash	25	65
<i>Gleditsia</i>	Locust	30	80
<i>Quercus robur</i>	English oak	20	55*
<i>Tilia cordata</i>	Lime	10	55

* The beech, and some oaks, tend to retain dead leaves for much of the winter, reaching bare branch condition only briefly before new leaf growth in the spring. The transparency value for beech is an average winter value.

NOTES: The data in Table H1 apply to individual tree crowns; multi-row belts or blocks may let virtually no radiation through when in leaf, and very little when in bare-branch condition. The values are averages from a range of sources, which show large differences for some of the values. The values must therefore be treated with caution, noting that in any case there will be considerable divergence in the transparencies of individual trees, especially in summer.

In cases of doubt, or for trees which are not included in Table H1, the transparency may be estimated on site from the proportion of the crown that appears to be visible sky. This may require site visits in both winter and summer.

H2.8 The British Standard *Code of practice for daylighting*, BS 8206-2^[H5], does not give guidance on this type of situation. However, if BS 8206-2 recommended values of ADF are exceeded in both summer and winter, then daylight would be considered adequate; and if the recommendations in BS 8206-2 minima are not reached in either summer or winter, then daylight would be considered inadequate. For a room where BS 8206-2 minimum value is exceeded in winter, but not in summer, daylight provision year round is likely to be adequate, but it is clear that the trees are having some effect on daylight.

H3 SUNLIGHT IN NEW DWELLINGS OBSTRUCTED BY TREES

H3.1 To assess the effect of trees on sunlight, eg to the main living room of a dwelling, a modified form of the above procedure can be used. First calculate the annual and winter (21 September to 21 March) probable sunlight hours as percentages (eg by using the sunlight availability indicators (Figures A2 to A4) in Appendix A), assuming the trees are completely opaque at all times and including the effects of obstruction by buildings. This should be based on a detailed site survey of tree profile. Calculate the summer probable sunlight hours by subtracting the winter value from the annual one.

H3.2 Repeat this process assuming there are no trees, only buildings. The annual probable sunlight hours (APSH) with the trees in place are then given by:

$$\begin{aligned} \text{APSH} &= \text{APSH with opaque trees} \\ &+ \text{winter transparency} / 100\% \times (\text{winter hours} \\ &\text{with no trees} - \text{winter hours with opaque trees}) + \\ &\text{summer transparency} / 100\% \times (\text{summer hours} \\ &\text{with no trees} - \text{summer hours with opaque trees}) \% \end{aligned}$$

H3.3 The winter probable sunlight hours WPSH with the trees in place are given by:

$$\begin{aligned} \text{WPSH} &= \text{winter hours with opaque trees} \\ &+ \text{winter transparency} / 100\% \times (\text{winter hours with} \\ &\text{no trees} - \text{winter hours with opaque trees}) \% \end{aligned}$$

H3.4 According to BS 8206-2^[H5] the interior should receive at least one quarter of APSH, including in the winter months at least 5% of APSH.

H4 SUNLIGHT IN GARDENS WITH TREES

H4.1 In assessing the impact of buildings on sunlight in gardens (see Section 3.3), trees and shrubs are not normally included in the calculation unless a dense belt or group of evergreens is specifically planned as a windbreak or for privacy purposes. This is partly because the dappled shade of a tree is more pleasant than the deep shadow of a building (this applies especially to deciduous trees).

H4.2 People vary in their preferences, and some like to have a shady, secluded garden. However, most people would be satisfied with some areas of partial shade under trees, and other parts of the garden or amenity area in full sun. If the whole of the garden is shaded by trees for a lengthy period of time in summer, the garden is probably too shady.

H5 EFFECT OF HEDGES

H5.1 High hedges may cause loss of sunlight and skylight to neighbouring gardens and houses. Under the Anti-Social Behaviour Act 2003, a local authority may require a hedge to be pruned if it is causing a nuisance, which can include if it is blocking too much sunlight or skylight.

H5.2 A separate document *Hedge height and light loss*^[H6] provides a way of calculating the height of a hedge that is likely to cause significant loss of light to a garden or house nearby. This method could be used by a hedge owner, or by an affected neighbour, to find out if a hedge is likely to block too much light to the neighbour's house or garden. The advice in the document is not mandatory, and is only one of the factors a local authority will need to take into account.

H5.3 In the Anti-Social Behaviour Act, 'high hedge' means 'so much of a barrier to light or access as (a) is formed wholly or predominantly by a line of two or more evergreens; and (b) rises to a height of more than two metres above ground level'.

Consequently, these guidelines apply to evergreen hedges. They have not been designed to be applied to individual trees, groups of trees or woodlands.

H5.4 *Hedge height and light loss*^[H6] introduces the concept of 'action hedge height' above which a hedge is likely to block too much light. It then gives a procedure to calculate this height both for a garden, and for windows to main rooms in a dwelling. The minimum action hedge height is 2 m.

H5.5 The procedure is intended to be simple enough for householders to use. It involves multiplying the distance from a window to the hedge, or the depth of the garden, by a factor; for gardens this factor depends on hedge orientation. Corrections can be made for site slope or where the hedge is set back from a garden boundary.

H5.6 For a small number of complex situations (eg where there is a building behind the hedge), or where the hedge is an irregular shape or has gaps in it, *Hedge height and light loss* suggests that the guidelines in this guide be used to assess loss of skylight and sunlight to windows. For this purpose, the skylight blocked by the hedge is likely to be significant if the VSC at the centre of the window is both less than 27% and less than 0.8 times

its value without the hedge in place (see Section 2.2). The loss of sunlight is likely to be significant if the APSH, at the centre of a main living room window, are less than 25% and less than 0.8 times the value without the hedge (see Section 3.2).

REFERENCES

- H1 BRE. Climate and site development: Part 1: General climate of the UK; Part 2: Influence of microclimate; Part 3: Improving microclimate through design. BRE DG 350. Bracknell, IHS BRE Press, 1983.
- H2 Littlefair P J et al. Environmental site layout planning: solar access, passive cooling and microclimate in urban areas. BRE BR 380. Bracknell, IHS BRE Press, 2000.
- H3 Yates D and McKennan G T. Solar architecture and light attenuation by trees: conflict or compromise? *Arboricultural Journal*, 1989, 13: 7–16.
- H4 Wilkinson D M, Yates D, and McKennan G T. Light attenuation characteristics of seven common British trees. *Arboricultural Journal*, 1991, 15: 37–44.
- H5 BSI. Code of practice for daylighting. BS 8206-2:2008. London, BSI, 2008.
- H6 DCLG. Hedge height and light loss. London, DCLG, 2004.
-

APPENDIX I

ENVIRONMENTAL IMPACT ASSESSMENT

11 The guidelines in this book may be used as the basis for environmental impact assessment, where the skylight and sunlight impact of a new development on its surroundings are taken into account.

12 Where a new development affects a number of existing buildings or open spaces, the clearest approach is usually to assess the impact on each one separately. It is also clearer to assess skylight and sunlight impacts separately.

13 Adverse impacts occur when there is a significant decrease in the amount of skylight and sunlight reaching an existing building where it is required, or in the amount of sunlight reaching an open space.

14 The assessment of impact will depend on a combination of factors, and there is no simple rule of thumb that can be applied.

15 Where the loss of skylight or sunlight fully meets the guidelines in this book, the impact is assessed as negligible or minor adverse. Where the loss of light is well within the guidelines, or only a small number of windows or limited area of open space lose light (within the guidelines), a classification of negligible impact is more appropriate. Where the loss of light is only just within the guidelines, and a larger number of windows or open space area are affected, a minor adverse impact would be more appropriate, especially if there is a particularly strong requirement for daylight and sunlight in the affected building or open space.

16 Where the loss of skylight or sunlight does not meet the guidelines in this book, the impact is assessed as minor, moderate or major adverse. Factors tending towards a minor adverse impact include:

- only a small number of windows or limited area of open space are affected
- the loss of light is only marginally outside the guidelines
- an affected room has other sources of skylight or sunlight

- the affected building or open space only has a low level requirement for skylight or sunlight
- there are particular reasons why an alternative, less stringent, guideline should be applied (see Appendix F).

17 Factors tending towards a major adverse impact include:

- a large number of windows or large area of open space are affected
- the loss of light is substantially outside the guidelines
- all the windows in a particular property are affected
- the affected indoor or outdoor spaces have a particularly strong requirement for skylight or sunlight, eg a living room in a dwelling or a children's playground.

18 Beneficial impacts occur when there is a significant increase in the amount of skylight and sunlight reaching an existing building where it is required, or in the amount of sunlight reaching an open space. Beneficial impacts should be worked out using the same principles as adverse impacts. Thus a tiny increase in light would be classified as a negligible impact, not a minor beneficial impact.

19 An adverse impact on one property cannot be balanced against negligible or beneficial impacts on other properties. In these situations it is more appropriate to quote a range of impacts.

110 The provision of new dwellings, or commercial or industrial buildings, or private gardens that meet the skylight or sunlight guidance in this book should not be classified as a beneficial daylight or sunlight impact on the local environment. However, the provision of community buildings or public open spaces with good skylight and/or sunlight could be classed as a beneficial impact.

INDEX

45° approach 8–9

A

access 26
 active solar thermal 24
 adjoining development land 11–13
 angle of visible sky (θ) 2–3, 6, 53–4, 70
 annual probable sunlight hours (APSH) 16–17, 45, 62, 71
 atriums 54, 68
 average daylight factor (ADF) 3–4, 6, 53–4, 63–4, 70–1

B

balconies 5–6, 8, 17
 basement windows 3
 bedrooms 4, 7, 14, 16, 53
 boundaries 11

C

car parking 18
 CIE standard overcast sky 2, 53, 61
 conservatories 14, 16, 26
 courtyards
 direction finder 43
 enclosure 26
 skylight indicator 44–5
 sunlight availability indicators 45, 46
 sunpath indicators 45, 47–8
 windows 4

D

daylight
 development land 11–13
 existing buildings 7–11
 interior 53–5
 new developments 2–6
 see also skylight
 dazzle 28
 development land 11–13
 direction finder 32, 40, 41–3

E

Edinburgh/Glasgow
 obstruction angles 22
 sun-on-ground indicator 65–8

sunlight availability indicator 32, 36
 sunpath indicator 32, 39
 enclosure 26
 environmental impact assessment 73
 equinox
 shadow plotting 19–20
 sunlight hours 18–19
 existing buildings
 daylight 7–11
 sunlight 16–17
 extensions 8–9
 external walls 5

F

fences 19, 25
 flats, sunlight 14–15
 future development 11–13

G

garages 4, 15, 22
 gardens 18–20, 25, 65, 73
 glare 28

H

hedges 19, 25, 70–2
 horizontal sky component (HSC) 54

I

interior daylighting 53–5

K

kitchens
 daylight 3, 4–5, 7, 53
 sunlight 14, 16, 22
 views 25

L

living rooms
 daylight 4, 53
 solar gain 22
 sunlight 14–15

London

 obstruction angles 22
 sun-on-ground indicator 65–8

sunlight availability indicator 32, 34
 sunpath indicator 32, 37

M

Manchester
 obstruction angles 22
 sun-on-ground indicator 65–8
 sunlight availability indicator 32, 35
 sunpath indicator 32, 38
 microclimate 26–7

N

new developments
 daylight 2–6
 sunlight 14–16
 no sky line 7–8, 54, 56–9
 non-domestic buildings 7, 14, 16
 north side of buildings 23, 25

O

obstruction angle 2–3, 6, 22, 54, 62
 open spaces, sunlight 18–20
 orientation
 active solar thermal 24
 passive solar energy 21–2
 sunlight 14–15
 overshadowing
 active solar thermal 24
 passive solar energy 22–3
 photovoltaics 24
 sunlight 15

P

passive solar energy 21–3
 patio doors 7, 9, 16, 54
 photovoltaics 24
 privacy 4, 25–6
 probable sunlight hours see annual probable sunlight hours

R

right to light 9, 60–1
 road layouts 21, 26
 room depth 6, 54

S

screening, privacy 25
security 26
shading, trees and hedges 19, 70–2
shadow plotting 19–20, 68–69
sky factor 60–1
skylight
 effect of trees and hedges 70–2
 target values 16, 62–4
 see also daylight
skylight indicator 2, 7, 11, 32–33,
 44–5
solar dazzle 28
solar energy 21–4
spacing-to-height ratio 3, 25–26, 63
sun-on-ground indicators 19, 65–9
sunlight
 effect of trees and hedges 71–2
 existing buildings 16–17
 gardens and open spaces 18–20

new developments 14–16

target values 62–4

sunlight availability indicators 16,
32, 34–6, 45–6

sunpath indicators 19, 32, 37–9,
45, 47–8

T

trees 19, 27, 70–1

tunnel effect 4, 9, 10

two hours sun contour 18–19

V

vertical sky component (VSC) 2–4,
6–9, 11, 44–5, 49, 53–4, 62–3,
64, 70

Waldram diagram 49–52

view 14, 18, 25

visible sky see angle of visible sky

W

Waldram diagram 2, 7, 11, 49–52,
60

walls, reflective 5

wind, shelter from 27

windows

 average daylight factor 53–4

 location 4

 orientation 14

 privacy 25–6

 size 3–4

winter, passive solar gains 23

working plane 7–8, 53–54, 56–58,
60

SITE LAYOUT PLANNING FOR DAYLIGHT AND SUNLIGHT

Fully revised and updated, this guide gives advice on site layout planning to achieve good sunlighting and daylighting both within buildings and in the open spaces between them. Widely used during the planning and design stages of building development, the new edition of BR 209 is a 'must have' for building and planning professionals.

What's new?

- provides a new method for assessing obstruction to daylight
- complements BS 8206-2 *Code of practice for daylighting*
- gives advice on obstruction and orientation of solar thermal and photovoltaic installations
- outlines the effects of dense urban areas, trees and hedges on buildings.



RELATED TITLES FROM IHS BRE PRESS

SUN-ON-GROUND INDICATORS

AP 288

ENVIRONMENTAL SITE LAYOUT PLANNING

BR 380

CALCULATING ACCESS TO SKYLIGHT, SUNLIGHT AND SOLAR RADIATION ON OBSTRUCTED SITES IN EUROPE

BR 379

SOLAR SHADING OF BUILDINGS

BR 364

DESIGNING BUILDINGS FOR DAYLIGHT

BR 288



bre press

IHS BRE Press, Willoughby Road
Bracknell, Berkshire RG12 8FB
www.brebookshop.com
BR 209

ISBN 978-1-84806-178-1



9 781848 061781